

# Tapping and ProStopp® DS

## Equipment Needed to Plug a 4" Gas Main to 300 psi



Technical Datasheet  
Date: Feb 2025

### Tapping

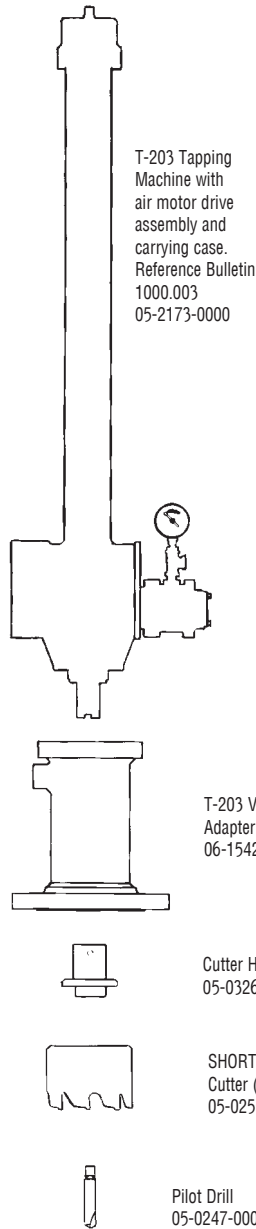

### Plugging

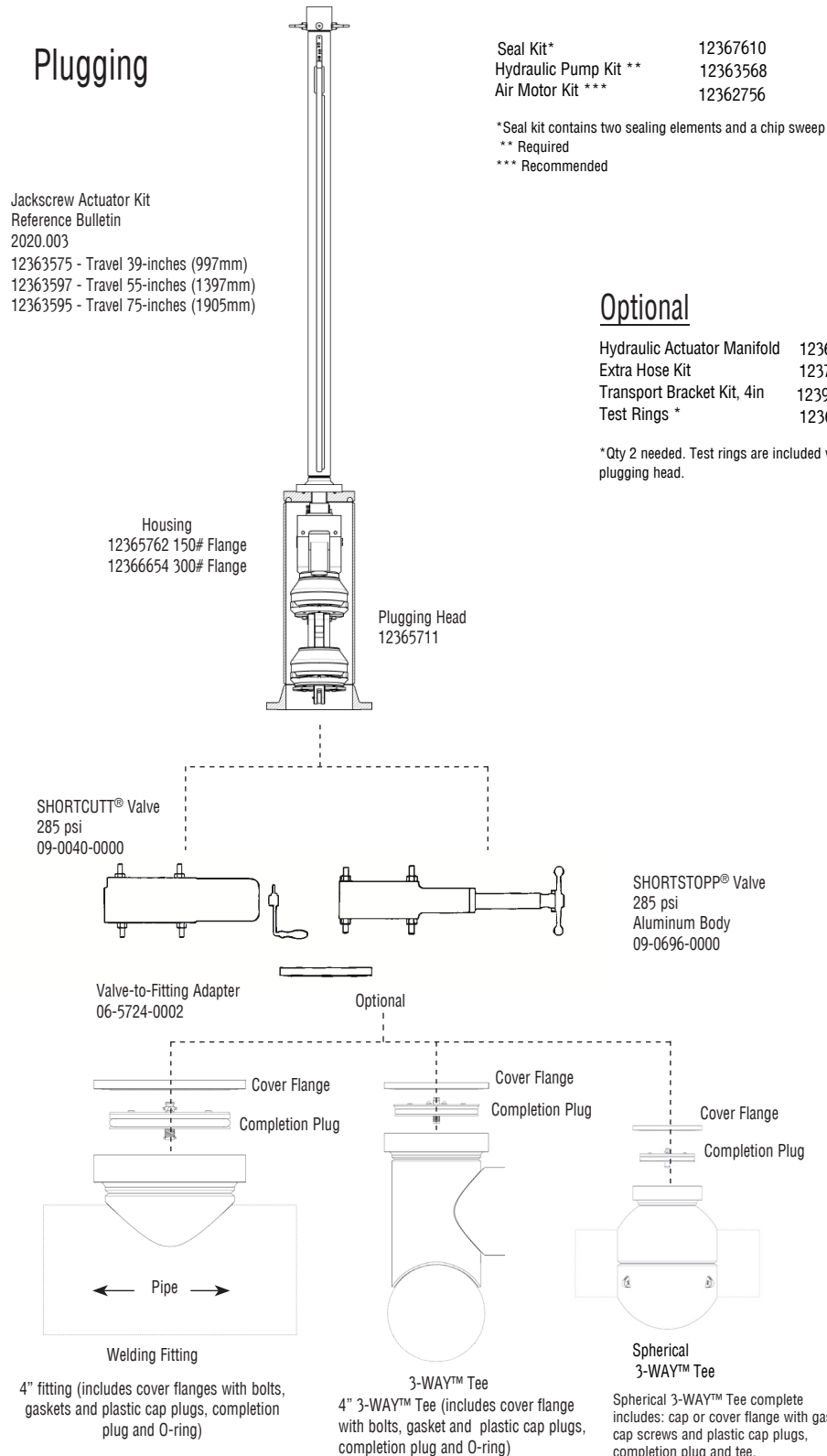

Seal Kit*	12367610
Hydraulic Pump Kit **	12363568
Air Motor Kit ***	12362756

\*Seal kit contains two sealing elements and a chip sweep  
\*\* Required  
\*\*\* Recommended

### Optional

Hydraulic Actuator Manifold	12361593
Extra Hose Kit	12378186
Transport Bracket Kit, 4in	12393708
Test Rings *	12369158

\*Qty 2 needed. Test rings are included with purchase of plugging head.



# ProStopp DS

## 4" Gas Main to 300 psi

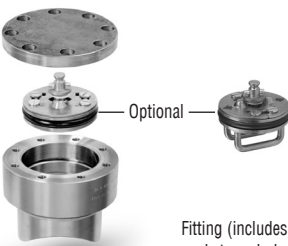
- 

Optional

■ Welding Fitting and SHORTPLUG™ with Guide Bars  
See Bulletin 2100.013

Fitting (includes cover flanges with bolts, gaskets and plastic caplugs, completion plug and O-ring)
- 

■ Welding Fitting  
See Bulletin 2100.003
- 

Optional

■ Spherical 3-WAY™ Tee and SHORTPLUG™ with Guide Bars  
See Bulletin 2100.014
- 

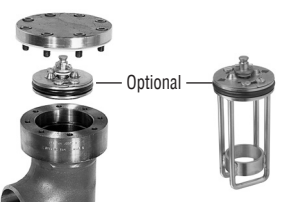
■ Spherical 3-WAY™ Tee  
See Bulletin 2100.007
- 

Optional

■ 3-WAY™ Tee and SHORTPLUG™ with Guide Bars  
See Bulletin 2100.012

3-WAY™ Tee (includes cover flange with bolts, gasket and plastic caplugs, completion plug and O-ring)
- 

■ 3-WAY™ Tee  
See Bulletin 2100.002
- 

■ Mechanical SHORTSLEEVE™ Fitting  
See Bulletin 2110.001

## Completion

SHORTSTOPP® Plugging/ Completion Machine  
Reference Bulletin 2020.002  
07-1034-0000

ProStopp DS  
Minor Maintenance Kit \* 12367609  
Major Maintenance Kit 12367608

Kits include O-rings and Guide Ring  
\*Kit should be used simultaneously with sealing element change-out

- Adapter 06-7265-0000
- 4" Valve Adapter 06-1542-0000
- Spool Adapter 06-1165-0176
- Completion Plug Holder 07-0334-0000
- Adapter 06-7264-0000
- SHORTSTOPP® Plugging Housing 08-0941-0000
- Spool Adapter 06-1165-0176
- Completion Plug Holder 07-0334-0000

Note: Consult your TDW representative for additional fitting options.

# Tapping and ProStopp® DS

## Equipment Needed to Plug a 6" Gas Main to 300 psi



Technical Datasheet  
Date: Feb 2025

### Tapping

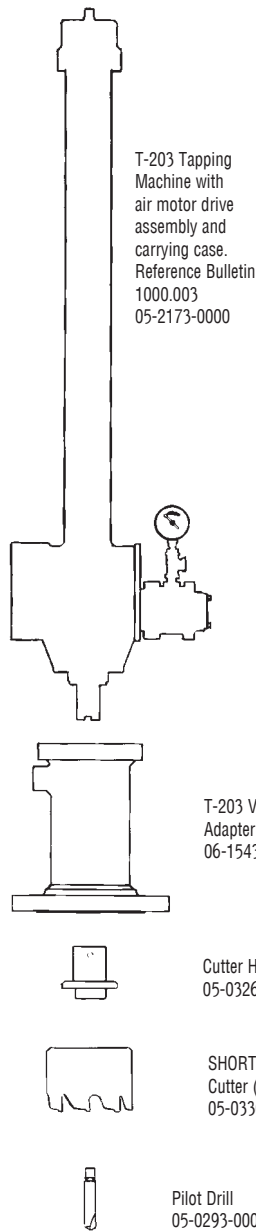

### Plugging

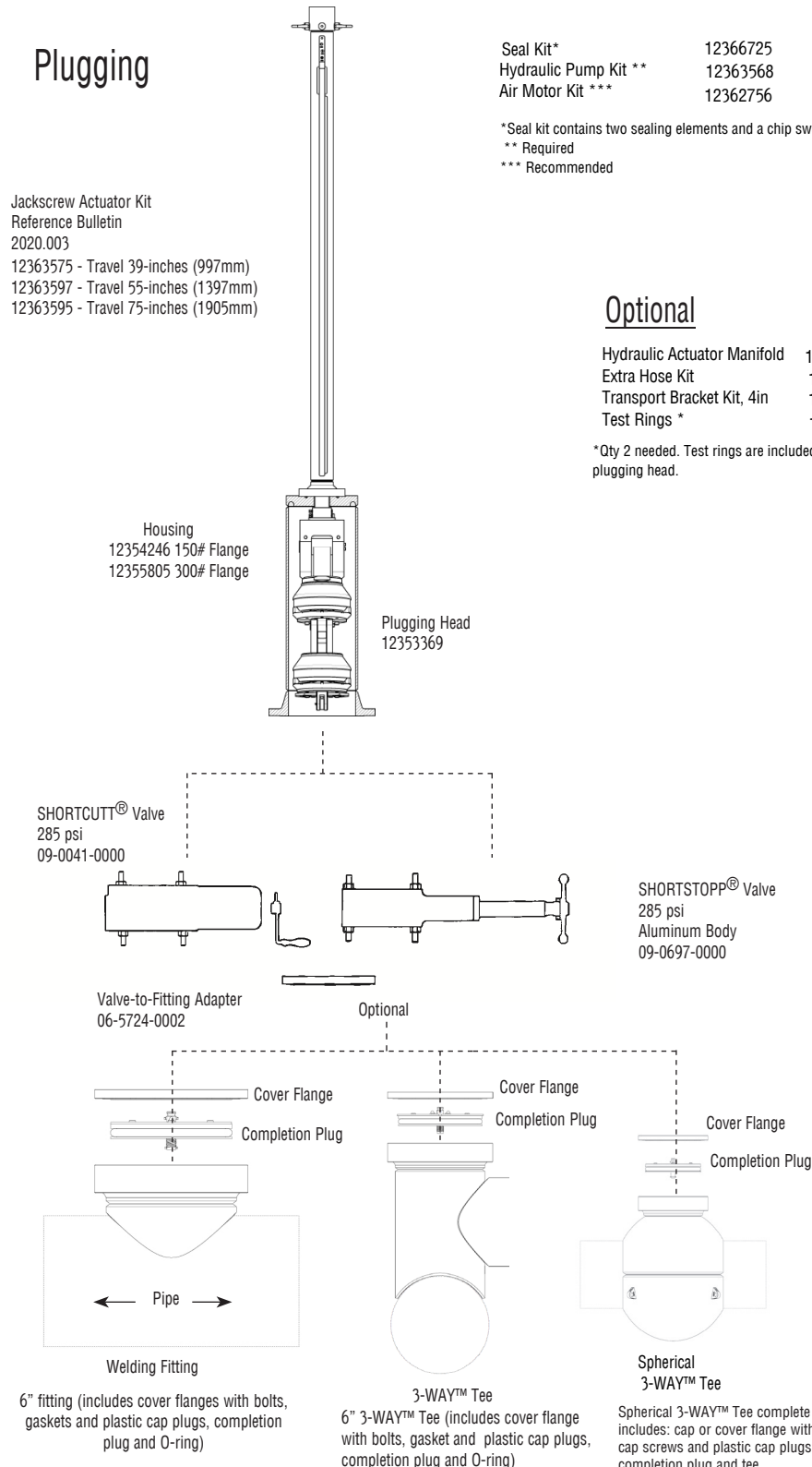

Seal Kit*	12366725
Hydraulic Pump Kit **	12363568
Air Motor Kit ***	12362756

\*Seal kit contains two sealing elements and a chip sweep  
\*\* Required  
\*\*\* Recommended

### Optional

Hydraulic Actuator Manifold	12361593
Extra Hose Kit	12378186
Transport Bracket Kit, 4in	12382856
Test Rings *	12369159

\*Qty 2 needed. Test rings are included with purchase of plugging head.



# ProStopp DS

## 6" Gas Main to 300 psi

- 

Optional 

■ Welding Fitting and SHORTPLUG™ with Guide Bars  
See Bulletin 2100.013

Fitting (includes cover flanges with bolts, gaskets and plastic caplugs, completion plug and O-ring)

■ Welding Fitting  
See Bulletin 2100.003
- 

Optional 

■ Spherical 3-WAY™ Tee and SHORTPLUG™ with Guide Bars  
See Bulletin 2100.014

■ Spherical 3-WAY™ Tee  
See Bulletin 2100.007
- 

Optional 

■ 3-WAY™ Tee and SHORTPLUG™ with Guide Bars  
See Bulletin 2100.012

3-WAY™ Tee (includes cover flange with bolts, gasket and plastic caplugs, completion plug and O-ring)

■ 3-WAY™ Tee  
See Bulletin 2100.002
- 

■ Mechanical SHORTSLEEVE™ Fitting  
See Bulletin 2110.001

### Completion

SHORTSTOPP® Plugging/ Completion Machine  
Reference Bulletin 2020.002 07-1034-0000

<p>Adapter 06-7265-0000</p> <p>6" Valve Adapter 06-1543-0000</p> <p>Spool Adapter 06-1165-0177</p> <p>Completion Plug Holder 07-0334-0000</p>	<p>ProStopp DS</p> <p>Minor Maintenance Kit * 12363500</p> <p>Major Maintenance Kit 12363499</p> <p>Kits include O-rings and Guide Ring *Kit should be used simultaneously with sealing element change-out</p> <p>Adapter 06-7264-0000</p> <p>SHORTSTOPP® Plugging Housing 08-0942-0000</p> <p>Spool Adapter 06-1165-0177</p> <p>Completion Plug Holder 07-0334-0000</p>
---	--

Note: Consult your TDW representative for additional fitting options.



# Tapping and ProStopp® DS

## Equipment Needed to Plug an 8" Gas Main to 300 psi

Technical Datasheet  
Date: Feb 2025

### Tapping

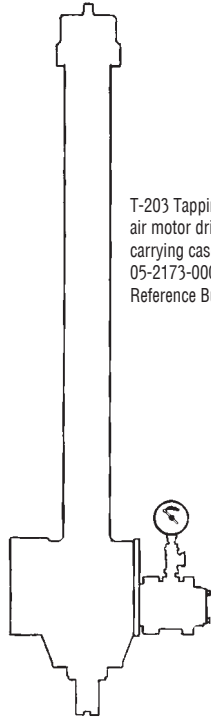

T-203 Tapping Machine with air motor drive assembly and carrying case. Stock No. 05-2173-0000 Reference Bulletin 1000.003

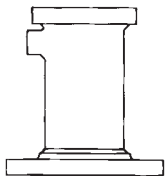

8" Valve Adapter  
06-1544-0000



Cutter Holder  
05-0326-0000



8" SHORTSTOPP® Cutter (nominal)  
05-0330-0008



Pilot Drill  
05-0293-0003

### Plugging

Jackscrew Actuator  
Reference Bulletin  
2020.003

12363575 - Travel 39-inches (997mm)  
12363597 - Travel 55-inches (1397mm)  
12363595 - Travel 75-inches (1905mm)

Housing  
12355404 150# Flange  
12355951 300# Flange

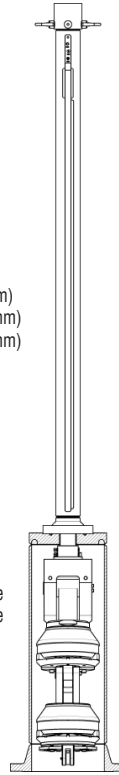

Plugging Head  
12355257

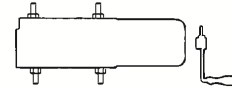

SHORTCUTT® Valve  
285 psi  
09-0042-0000

Valve-to-Fitting Adapter  
06-5724-0003

Optional

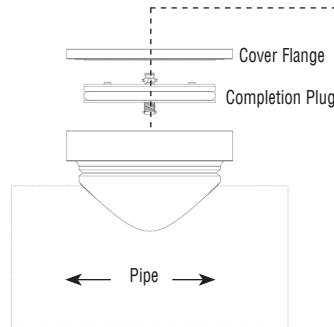

Welding Fitting

8" fitting (includes cover flanges with bolts, gaskets and plastic cap plugs, completion plug and O-ring)

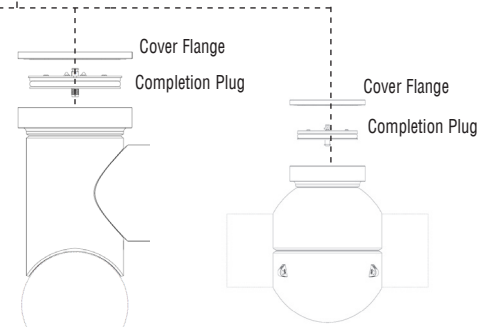

3-WAY™ Tee

8" 3-WAY™ Tee (includes cover flange with bolts, gasket and plastic cap plugs, completion plug and O-ring)

Spherical 3-WAY™ Tee

Spherical 3-WAY™ Tee complete includes: cap or cover flange with gasket, cap screws and plastic cap plugs, completion plug and tee.

Seal Kit\* 12366726  
Hydraulic Pump Kit \*\* 12363568  
Air Motor Kit \*\*\* 12362756

\* Seal kit contains two sealing elements and a chip sweep  
\*\* Required  
\*\*\* Recommended

### Optional

Hydraulic Actuator Manifold 12361593  
Extra Hose Kit 12378186  
Transport Bracket Kit, 8in 12382857  
Test Rings \* 12369160

\* Qty 2 needed. Test rings are included with purchase of plugging head.



# ProStopp DS

## 8" Gas Main to 300 psi

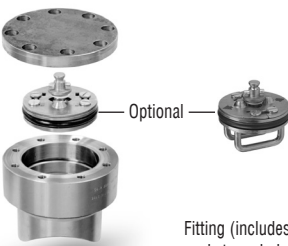
- 

Optional

■ Welding Fitting and SHORTPLUG™ with Guide Bars  
See Bulletin 2100.013

Fitting (includes cover flanges with bolts, gaskets and plastic caplugs, completion plug and O-ring)

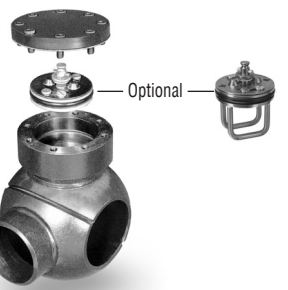
■ Welding Fitting  
See Bulletin 2100.003
- 

Optional

■ Spherical 3-WAY™ Tee and SHORTPLUG™ with Guide Bars  
See Bulletin 2100.014

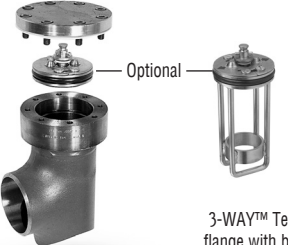
■ Spherical 3-WAY™ Tee  
See Bulletin 2100.007
- 

Optional

■ 3-WAY™ Tee and SHORTPLUG™ with Guide Bars  
See Bulletin 2100.012

3-WAY™ Tee (includes cover flange with bolts, gasket and plastic caplugs, completion plug and O-ring)

■ 3-WAY™ Tee  
See Bulletin 2100.002
- 

■ Mechanical SHORTSLEEVE™ Fitting  
See Bulletin 2110.001

### Completion

SHORTSTOPP® Plugging/ Completion Machine  
Reference Bulletin 2020.002  
07-1034-0000

ProStopp DS

- Minor Maintenance Kit \* 12363502
- Major Maintenance Kit 12363501

Kits include O-rings and Guide Ring  
\*Kit should be used simultaneously with sealing element change-out

- Adapter 06-7265-0000
- 8" Valve Adapter 06-1544-0000
- Spool Adapter 06-1165-0178\*
- Completion Plug Holder 07-0334-0000
- 06-7264-0000 Adapter
- 8" Plugging Head Housing 08-0943-0000
- Completion Plug Holder 07-0334-0000

Note 1: \* 8-inch Spool Adapter required to set 8-inch SHORTPLUG™ with Guide Bars in SHORTSTOPP Type II 3-Way™ Tee fittings using the 06-1544-0000 Adapter.

Note 2: Consult your TDW representative for additional fitting options.



Technical Datasheet  
Date: Feb 2025

# Tapping and ProStopp® DS

## Equipment Needed to Plug a 10" Gas Main to 300 psi

\*10" applications use 12" equipment

### Tapping

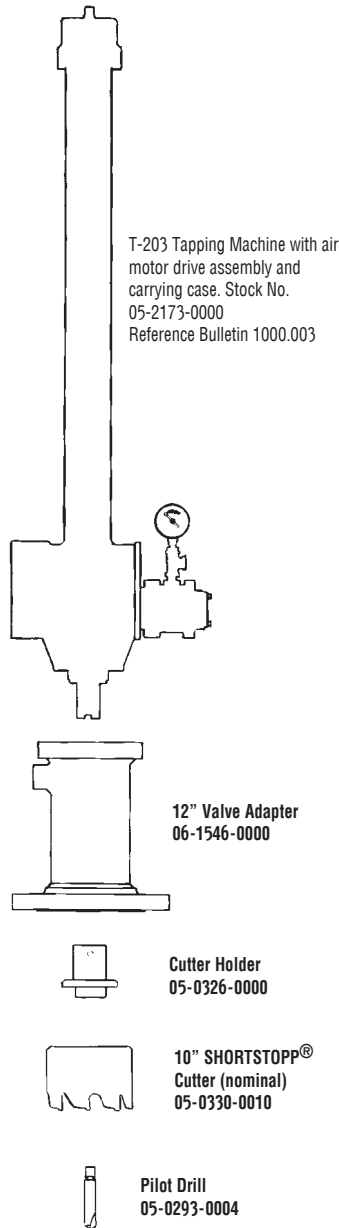

### Plugging

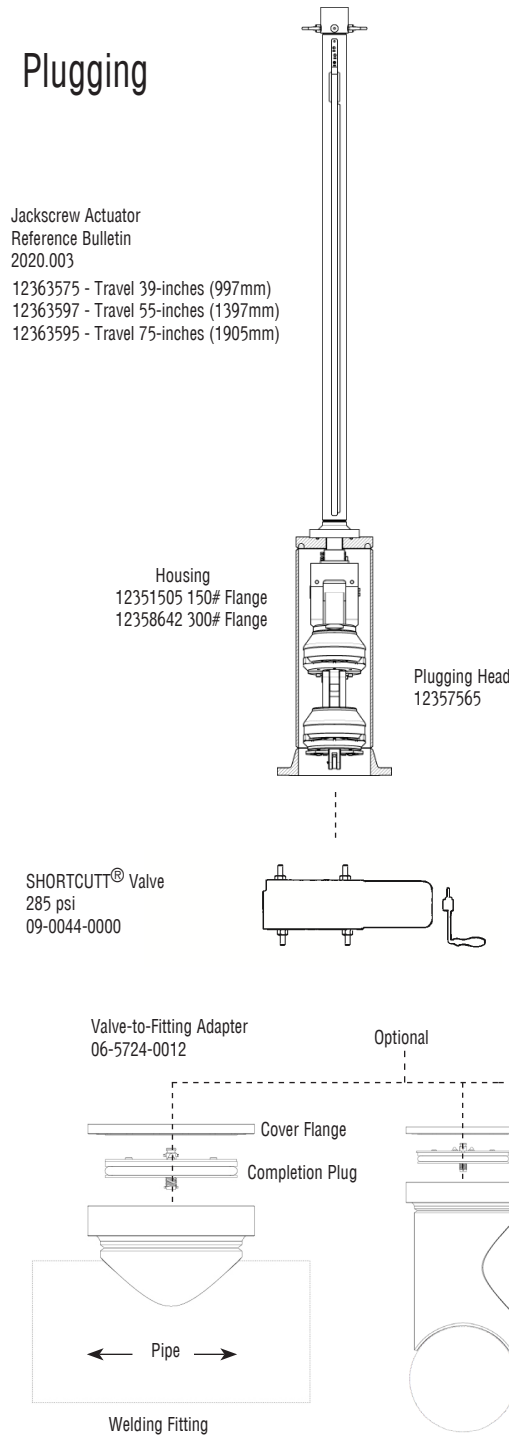

10" fitting (includes cover flanges with bolts, gaskets and plastic cap plugs, completion plug and O-ring)

10" 3-WAY™ Tee (includes cover flange with bolts, gasket and plastic cap plugs, completion plug and O-ring)

Spherical 3-WAY™ Tee complete includes: cap or cover flange with gasket, cap screws and plastic cap plugs, completion plug and tee.

Seal Kit*	12366727
Hydraulic Pump Kit **	12363568
Air Motor Kit ***	12362756

\*Seal kit contains two sealing elements and a chip sweep  
\*\* Required  
\*\*\* Recommended

### Optional

Hydraulic Actuator Manifold	12361593
Extra Hose Kit	12378186
Transport Bracket Kit, 12in	12382858
Test Rings *	12369161

\* Qty 2 needed. Test rings are included with purchase of plugging head.



# ProStopp DS

## 10" Gas Main to 300 psi

Optional

- Welding Fitting and SHORTPLUG™ with Guide Bars  
See Bulletin 2100.013

Fitting (includes cover flanges with bolts, gaskets and plastic caplugs, completion plug and O-ring)

- Welding Fitting  
See Bulletin 2100.003

Optional

- Spherical 3-WAY™ Tee and SHORTPLUG™ with Guide Bars  
See Bulletin 2100.014

- Spherical 3-WAY™ Tee  
See Bulletin 2100.007

Optional

- 3-WAY™ Tee and SHORTPLUG™ with Guide Bars  
See Bulletin 2100.012

3-WAY™ Tee (includes cover flange with bolts, gasket and plastic caplugs, completion plug and O-ring)

- 3-WAY™ Tee  
See Bulletin 2100.002

- Mechanical SHORTSLEEVE™ Fitting  
See Bulletin 2110.001

### Completion

ProStopp DS

- Minor Maintenance Kit \* 12363504
- Major Maintenance Kit 12363503

Kits include O-rings and Guide Ring  
\*Kit should be used simultaneously with sealing element change-out

- SHORTSTOPP® Plugging/ Completion Machine Reference Bulletin 2020.002 07-1034-0000
- Adapter 06-7265-0000
- 12" Valve Adapter 06-1546-0000
- Spool Adapter 06-1165-0180 \*
- Completion Plug Holder 07-0335-0000
- Adapter 06-7264-0000
- 12" Plugging Head Housing 08-0945-0000
- Completion Plug Holder 07-0335-0000

Note 1: \*12-inch Spool Adapter required to set 10-inch SHORTPLUG™ with Guide Bars in SHORTSTOPP Type II 3-Way™ Tee fittings using the 06-1546-0000 Adapter and 07-1586-0000 Completion Machine

Note 2: Consult your TDW representative for additional fitting options.





Technical Datasheet  
Date: Feb 2025

# Tapping and ProStopp® DS

## Equipment Needed to Plug a 12" Gas Main to 300 psi

### Tapping

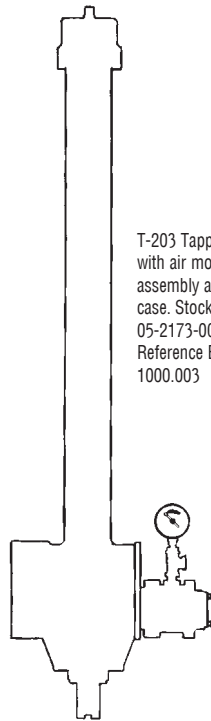

T-203 Tapping Machine with air motor drive assembly and carrying case. Stock No. 05-2173-0000 Reference Bulletin 1000.003

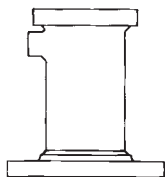

12" Valve Adapter  
06-1546-0000



Cutter Holder  
05-0326-0000



12" SHORTSTOPP®  
Cutter (nominal)  
05-0330-0012



Pilot Drill  
05-0293-0005

### Plugging

Jackscrew Actuator  
Reference Bulletin  
2020.003

12363575 - Travel 39-inches (997mm)  
12363597 - Travel 55-inches (1397mm)  
12363595 - Travel 75-inches (1905mm)

Housing  
12351505 150# Flange  
12358642 300# Flange

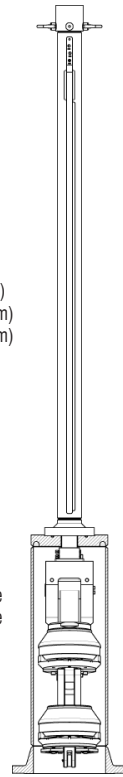

Plugging Head  
12350480

SHORTCUTT® Valve  
285 psi  
09-0044-0000

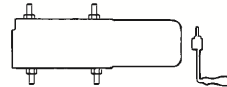

Valve-to-Fitting Adapter  
06-5724-0011

Optional

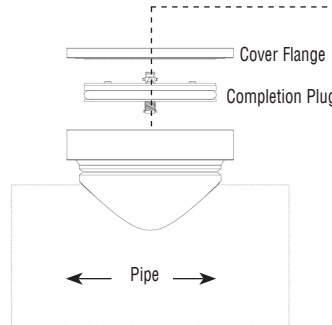

Welding Fitting

12" fitting (includes cover flanges with bolts, gaskets and plastic cap plugs, completion plug and O-ring)

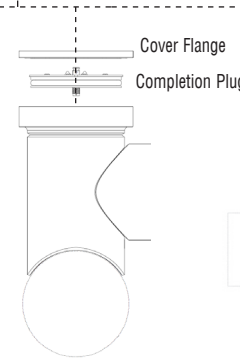

3-WAY™ Tee

12" 3-WAY™ Tee (includes cover flange with bolts, gasket and plastic cap plugs, completion plug and O-ring)

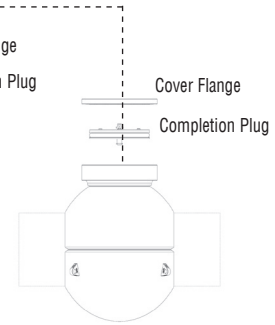

Spherical 3-WAY™ Tee

Spherical 3-WAY™ Tee complete includes: cap or cover flange with gasket, cap screws and plastic cap plugs, completion plug and tee.

Seal Kit\* 12366728  
Hydraulic Pump Kit \*\* 12363568  
Air Motor Kit \*\*\* 12362756

\* Seal kit contains two sealing elements and a chip sweep  
\*\* Required  
\*\*\* Recommended

### Optional

Hydraulic Actuator Manifold 12361593  
Extra Hose Kit 12378186  
Transport Bracket Kit, 12in 12382858  
Test Rings \* 12369162

\* Qty 2 needed. Test rings are included with purchase of plugging head.



# ProStopp DS

## 12" Gas Main to 300 psi

- 

Optional 

■ Welding Fitting and SHORTPLUG™ with Guide Bars  
See Bulletin 2100.013

Fitting (includes cover flanges with bolts, gaskets and plastic caplugs, completion plug and O-ring)

■ Welding Fitting  
See Bulletin 2100.003
- 

Optional 

■ Spherical 3-WAY™ Tee and SHORTPLUG™ with Guide Bars  
See Bulletin 2100.014

■ Spherical 3-WAY™ Tee  
See Bulletin 2100.007
- 

Optional 

■ 3-WAY™ Tee and SHORTPLUG™ with Guide Bars  
See Bulletin 2100.012

3-WAY™ Tee (includes cover flange with bolts, gasket and plastic caplugs, completion plug and O-ring)

■ 3-WAY™ Tee  
See Bulletin 2100.002
- 

■ Mechanical SHORTSLEEVE™ Fitting  
See Bulletin 2110.001

### Completion

SHORTSTOPP® Plugging/ Completion Machine  
Reference Bulletin 2020.002  
07-1034-0000

ProStopp DS

- Minor Maintenance Kit \* 12363492
- Major Maintenance Kit 12363445

Kits include O-rings and Guide Ring  
\*Kit should be used simultaneously with sealing element change-out

- Adapter 06-7265-0000
- 12" Valve Adapter 06-1546-0000
- Spool Adapter 06-1165-0180\*
- Completion Plug Holder 07-0335-0000
- Adapter 06-7264-0000
- 12" Plugging Head Housing 08-0945-0000
- Completion Plug Holder 07-0335-0000

Note 1: Consult your TDW representative for additional fitting options.

Note 2: \*The 07-1586-0000 Completion Machine with 48" travel is required to set 12" SHORTPLUG™ with Guide Bars in SHORTSTOPP Type II 3-Way™ Tee fittings using the 06-1546-0000 Adapter.