

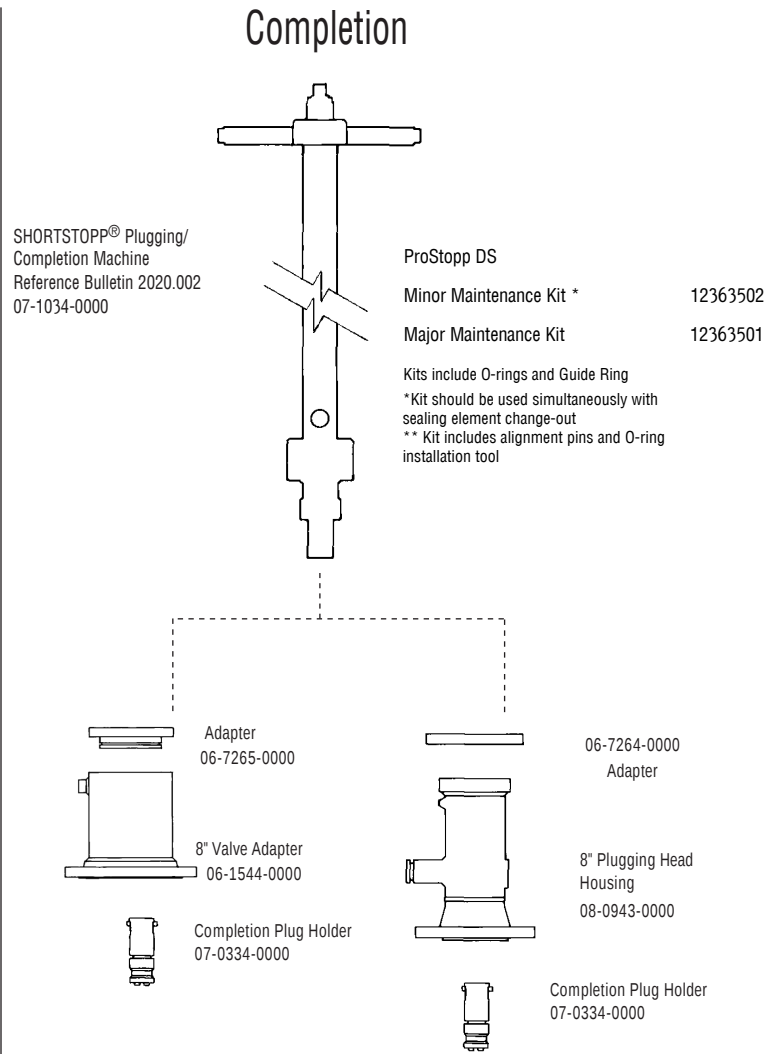

ProStopp DS

Gas Main to psi

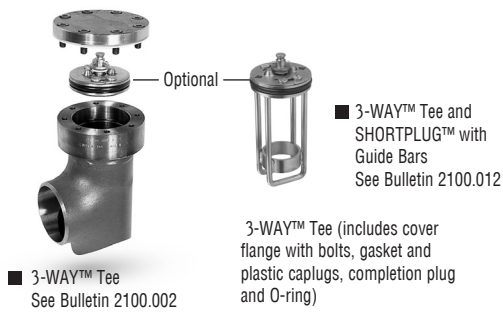
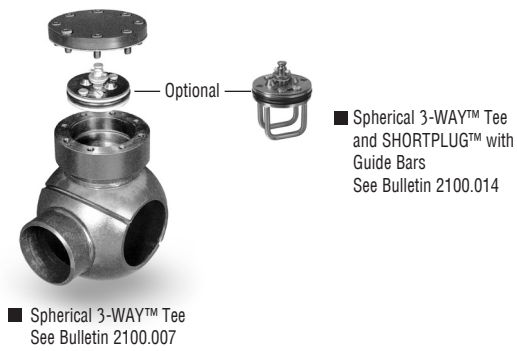
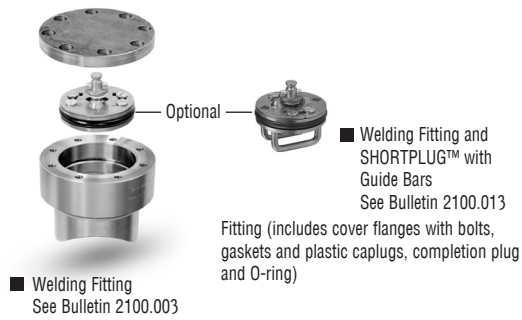

Note: Consult your TDW representative for additional fitting options.



Tapping and ProStopp™ DS

Equipment Needed to Plug a 10-inch Gas Main to 275psi

*10-inch applications use 12-inch equipment

CE Compliant and Compatible for Thin Wall Applications

Tapping

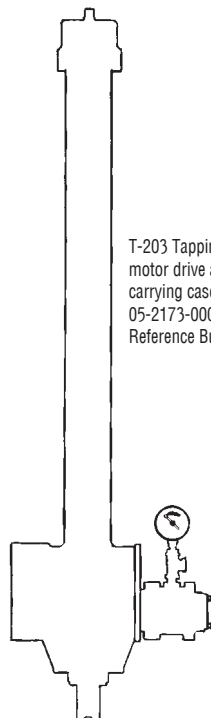

T-203 Tapping Machine with air motor drive assembly and carrying case. Stock No. 05-2173-0000 Reference Bulletin 1000.003

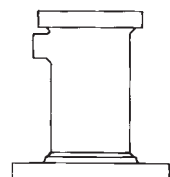

12" Valve Adapter
06-1546-0000



Cutter Holder
05-0326-0000



10" SHORTSTOPP®
Cutter (nominal)
05-0330-0010



Pilot Drill
05-0293-0004

Plugging

Jackscrew Actuator
Reference Bulletin
2020.003

12363575CE - Travel 39-inches (997mm)
12363597CE - Travel 55-inches (1397mm)
12363595CE - Travel 75-inches (1905mm)

Housing
12364770 150# Flange
12364787 300# Flange



Plugging Head
12382750

SHORTCUTT® Valve
DN300 CE
12303408

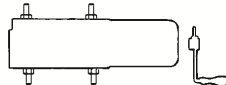

Valve-to-Fitting Adapter
06-5724-0012

Optional

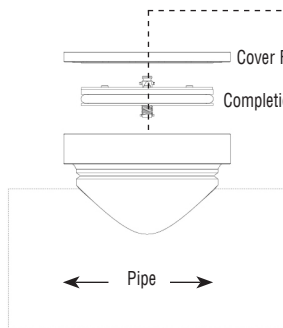

Welding Fitting

10" fitting (includes cover flanges with bolts, gaskets and plastic cap plugs, completion plug and O-ring)

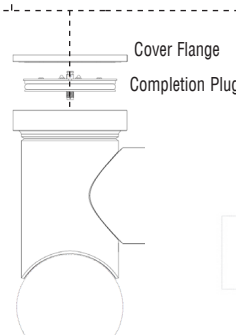

3-WAY™ Tee

10" 3-WAY™ Tee (includes cover flange with bolts, gasket and plastic cap plugs, completion plug and O-ring)

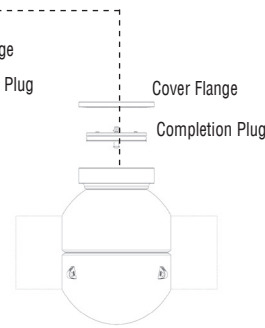

Spherical
3-WAY™ Tee

Spherical 3-WAY™ Tee complete includes: cap or cover flange with gasket, cap screws and plastic cap plugs, completion plug and tee.

Seal Kit* 12366727
Hydraulic Pump Kit ** 12363568
Air Motor Kit *** 12362756
Test Rings **** 12369161

*Seal kit contains two sealing elements, a chip sweep, O-rings, alignment pins, and O-ring installation tools.

** Required

*** Recommended

**** Qty 2 needed



ProStopp DS

10-inch Gas Main to 300 psi

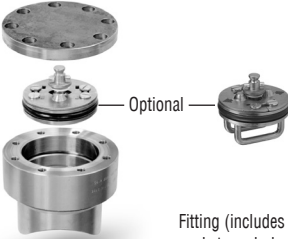
- 

Optional

■ Welding Fitting and SHORTPLUG™ with Guide Bars
See Bulletin 2100.013

Fitting (includes cover flanges with bolts, gaskets and plastic caplugs, completion plug and O-ring)

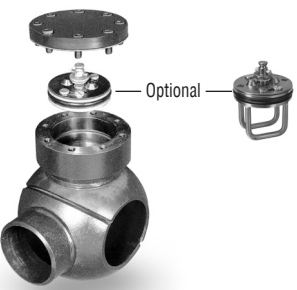
■ Welding Fitting
See Bulletin 2100.003
- 

Optional

■ Spherical 3-WAY™ Tee and SHORTPLUG™ with Guide Bars
See Bulletin 2100.014

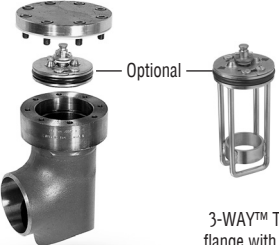
■ Spherical 3-WAY™ Tee
See Bulletin 2100.007
- 

Optional

■ 3-WAY™ Tee and SHORTPLUG™ with Guide Bars
See Bulletin 2100.012

3-WAY™ Tee (includes cover flange with bolts, gasket and plastic caplugs, completion plug and O-ring)

■ 3-WAY™ Tee
See Bulletin 2100.002
- 

■ Mechanical SHORTSLEEVE™ Fitting
See Bulletin 2110.001

Completion

SHORTSTOPP® Plugging/
Completion Machine
Reference Bulletin
2020.002
07-1034-0000

ProStopp DS

Minor Maintenance Kit * 12363504

Major Maintenance Kit 12363503

Kits include O-rings and Guide Ring
*Kit should be used simultaneously with sealing element change-out
** Kit includes alignment pins and O-ring installation tool

- Adapter 06-7265-0000
- 12" Valve Adapter 06-1546-0000
- Completion Plug Holder 07-0335-0000
- Adapter 06-7264-0000
- 12" Plugging Head Housing 08-0945-0000
- Completion Plug Holder 07-0335-0000

Note: Consult your TDW representative for additional fitting options.



Tapping and ProStopp™ DS

Equipment Needed to Plug a 12-inch Gas Main to 275 psi CE Compliant and Compatible for Thin Wall Applications

Tapping

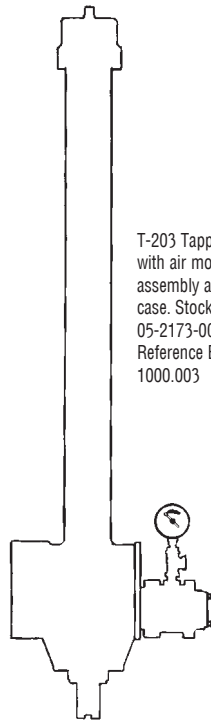

T-203 Tapping Machine
with air motor drive
assembly and carrying
case. Stock No.
05-2173-0000
Reference Bulletin
1000.003

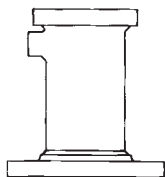

12" Valve Adapter
06-1546-0000



Cutter Holder
05-0326-0000



12" SHORTSTOPP®
Cutter (nominal)
05-0330-0012



Pilot Drill
05-0293-0005

Plugging

Jackscrew Actuator
Reference Bulletin
2020.003

12363575CE - Travel 39-inches (997mm)
12363597CE - Travel 55-inches (1397mm)
12363595CE - Travel 75-inches (1905mm)

Housing
12364770 150# Flange
12364787 300# Flange

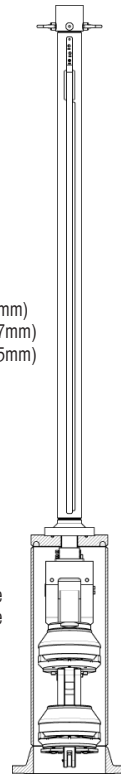

Plugging Head
12382767

SHORTCUTT® Valve
DN300 CE
12303408

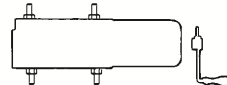

Valve-to-Fitting Adapter
06-5724-0011

Optional

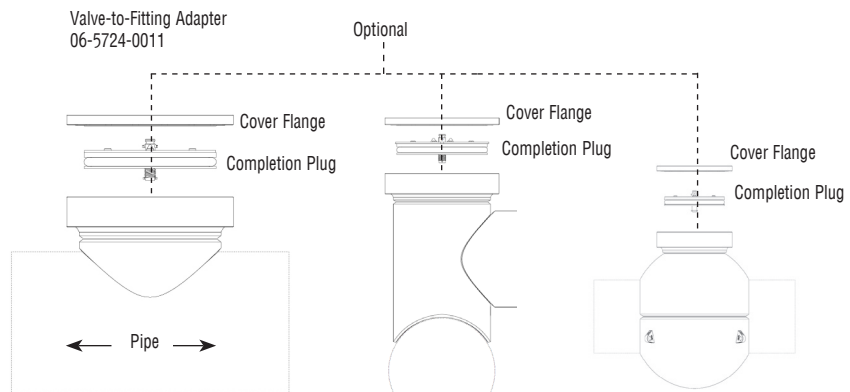

12" fitting (includes cover flanges with bolts,
gaskets and plastic cap plugs, completion
plug and O-ring)

3-WAY™ Tee
12" 3-WAY™ Tee (includes cover flange
with bolts, gasket and plastic cap plugs,
completion plug and O-ring)

Spherical
3-WAY™ Tee
Spherical 3-WAY™ Tee complete
includes: cap or cover flange with gasket,
cap screws and plastic capplugs,
completion plug and tee.

| | |
|-----------------------|----------|
| Seal Kit* | 12366728 |
| Hydraulic Pump Kit ** | 12363568 |
| Air Motor Kit *** | 12362756 |
| Test Rings **** | 12369162 |

*Seal kit contains two sealing elements, a chip sweep,
O-rings, alignment pins, and O-ring installation tools.

** Required

*** Recommended

**** Qty 2 needed



ProStopp DS

12-inch Gas Main to 300 psi

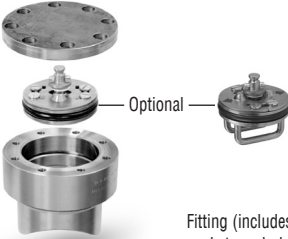
- 

Optional

■ Welding Fitting and SHORTPLUG™ with Guide Bars
See Bulletin 2100.013

Fitting (includes cover flanges with bolts, gaskets and plastic caplugs, completion plug and O-ring)
- 

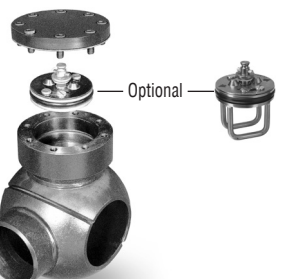
■ Welding Fitting
See Bulletin 2100.003
- 

Optional

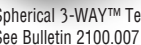
■ Spherical 3-WAY™ Tee and SHORTPLUG™ with Guide Bars
See Bulletin 2100.014
- 

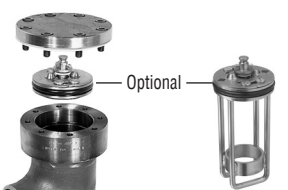
■ Spherical 3-WAY™ Tee
See Bulletin 2100.007
- 

Optional

■ 3-WAY™ Tee and SHORTPLUG™ with Guide Bars
See Bulletin 2100.012

3-WAY™ Tee (includes cover flange with bolts, gasket and plastic caplugs, completion plug and O-ring)
- 

■ 3-WAY™ Tee
See Bulletin 2100.002
- 

■ Mechanical SHORTSLEEVE™ Fitting
See Bulletin 2110.001

Completion

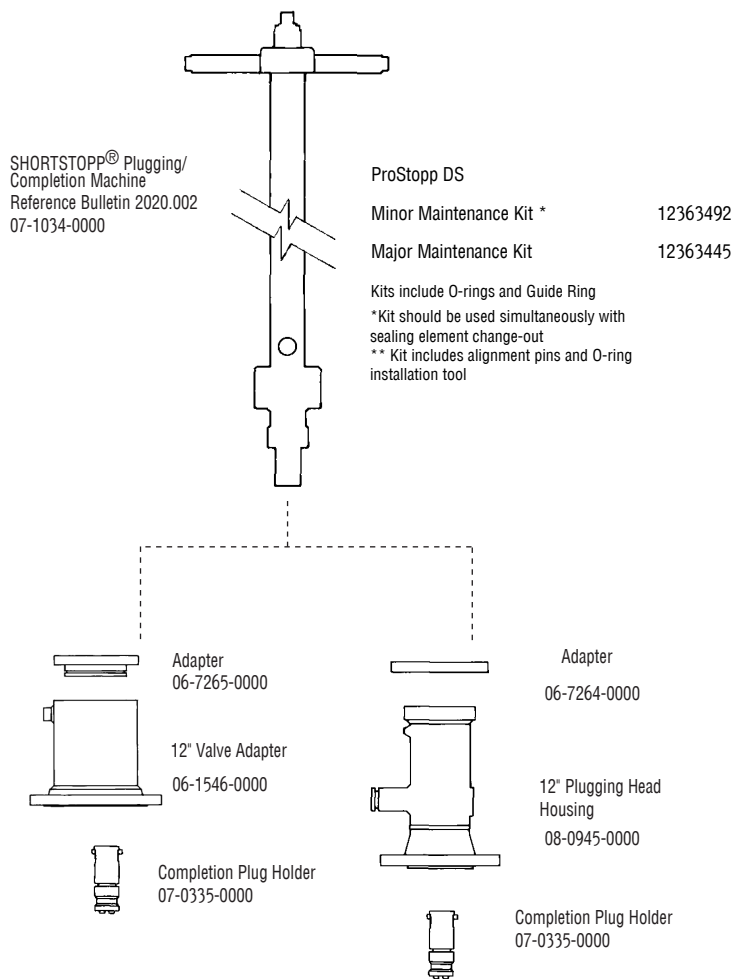

Note 1: Consult your TDW representative for additional fitting options.

Note 2: *The 07-1586-0000 Completion Machine with 48" travel is required to set 12" SHORTPLUG™ with Guide Bars in SHORTSTOPP Type II 3-Way™ Tee fittings using the 06-1546-0000 Adapter.