

Tapping and SHORTSTOPP® Plugging Machine

Equipment Needed to Plug a 2" Gas Main to 500 psi



T.D. Williamson, Inc.

Data Sheet No. **SS500-2**

Date: September 2002

Supersedes: March 1999

Tapping

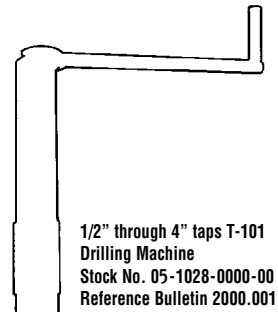

1/2" through 4" taps T-101
Drilling Machine
Stock No. 05-1028-0000-00
Reference Bulletin 2000.001

Bleeder Valve and Nipple included
with T-101 Drilling Machine

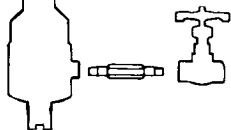

2" Valve Adapter
00-0706-0015

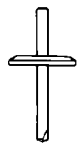

Holder Pilot
05-0204-0000



2" Hole Saw
05-0179-0002

Plugging

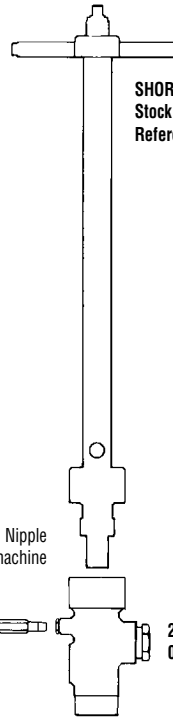

SHORTSTOPP® Plugging / Completion Machine
Stock No. 07-1034-0000
Reference Bulletin 2020.002

Bleeder Valve and Nipple
included with machine

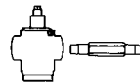

2" Housing
08-1746-0000

2" Plugging Head
08-2252-0000

Sealing Cup
08-3425-0002-SUFF



2" SHORTCUTT®
500 Valve
09-0758-0000
500 PSI

Handle

Optional**

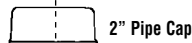

2" Pipe Cap



Completion Plug
with O-ring***



2" Pipe Cap



Completion Plug with O-ring***

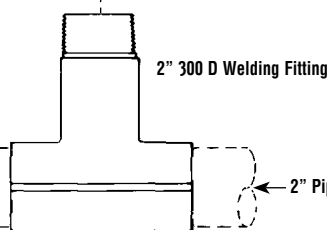

2" 300 D Welding Fitting

2" 300 D Welding Fitting (includes
completion plug, O-ring, and pipe cap)
Stock No. 26-0214-0000



2" 300 D 3-WAY™ Tee

2" 300 D 3-WAY™ Tee (includes
completion plug, O-ring, and pipe cap)
Stock No. 26-0222-0000

**Refer to back for fitting options.

***Refer to back for completion.



T.D. Williamson, Inc.

Data Sheet No. **SS500-2**

Fittings

Tapping and **SHORTSTOPP®** Plugging Machine 2" Gas Main to 500 psi



■ 300 D Welding Fitting
See Bulletin 2100.004



■ 300 D Spherical 3-WAY™ Tee
See Bulletin 2100.008



■ 300 D 3-WAY™ Tee
See Bulletin 2100.006

■ Note: Consult your TDW representative for additional fitting options.

Completion

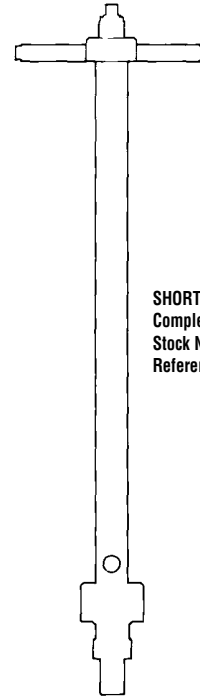

SHORTSTOPP® Plugging/
Completion Machine
Stock No. 07-1034-0000
Reference Bulletin 2020.002

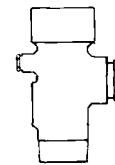

2" Housing
08-1746-0000



Completion Plug Holder
07-0974-0000

Data Sheet No. **SS500-2**

Tapping and SHORTSTOPP® Plugging Machine

Equipment Needed to Plug a 3" Gas Main to 500 psi



T.D. Williamson, Inc.

Data Sheet No. **SS500-3**

Date: September 2002

Supersedes: March 1999

Tapping

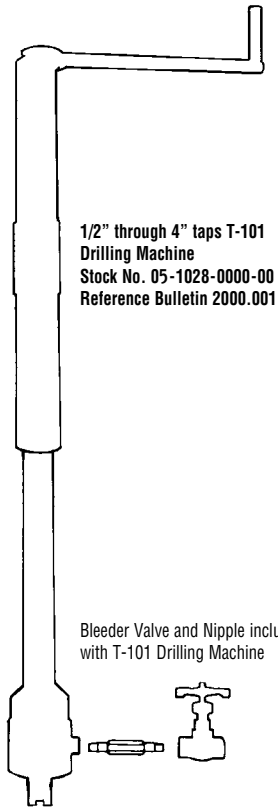

1/2" through 4" taps T-101
Drilling Machine
Stock No. 05-1028-0000-00
Reference Bulletin 2000.001

Bleeder Valve and Nipple included
with T-101 Drilling Machine

3" Valve Adapter
06-1303-0001

Holder Pilot
05-0204-0000

3" Hole Saw
(nominal)
05-0179-0003

Plugging

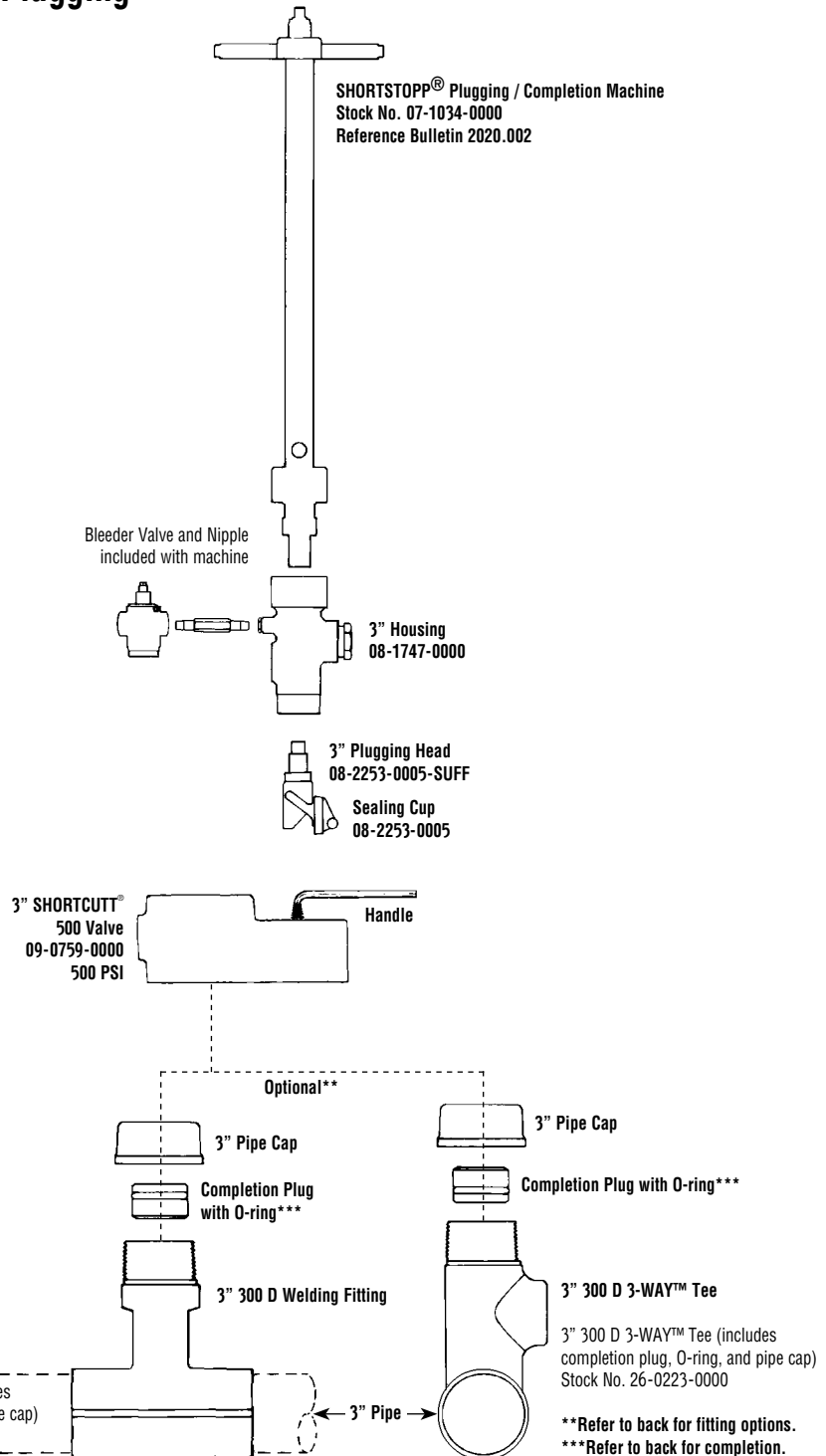

SHORTSTOPP® Plugging / Completion Machine
Stock No. 07-1034-0000
Reference Bulletin 2020.002

Bleeder Valve and Nipple
included with machine

3" Housing
08-1747-0000

3" Plugging Head
08-2253-0005-SUFF
Sealing Cup
08-2253-0005

3" SHORTCUTT®
500 Valve
09-0759-0000
500 PSI

Handle

Optional**

3" Pipe Cap

Completion Plug
with O-ring***

3" 300 D Welding Fitting

3" Pipe Cap

Completion Plug with O-ring***

3" 300 D 3-WAY™ Tee

3" 300 D 3-WAY™ Tee (includes
completion plug, O-ring, and pipe cap)
Stock No. 26-0223-0000

3" 300 D Welding Fitting (includes
completion plug, O-ring, and pipe cap)
Stock No. 26-0215-0000

3" Pipe

**Refer to back for fitting options.
***Refer to back for completion.



T.D. Williamson, Inc.

Data Sheet No. **SS500-3**

Fittings

Tapping and **SHORTSTOPP®** Plugging Machine 3" Gas Main to 500 psi



■ 300 D Welding Fitting
See Bulletin 2100.004



■ 300 D Spherical 3-WAY™ Tee
See Bulletin 2100.008



■ 300 D 3-WAY™ Tee
See Bulletin 2100.006

■ Note: Consult your TDW representative for additional fitting options.

Completion

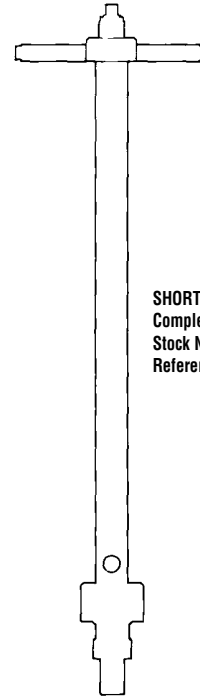

SHORTSTOPP® Plugging/
Completion Machine
Stock No. 07-1034-0000
Reference Bulletin 2020.002



3" Housing
08-1747-0000



Completion Plug Holder
07-0974-0000

Data Sheet No. **SS500-3**

Tapping and SHORTSTOPP[®] Plugging Machine

*Equipment Needed to Plug a 4" Gas Main to 500 psi
Using Completion Machine*



T.D. Williamson, Inc.

Data Sheet No. **SS500-4**

Date: November 2004

Supersedes: September 2002

Tapping

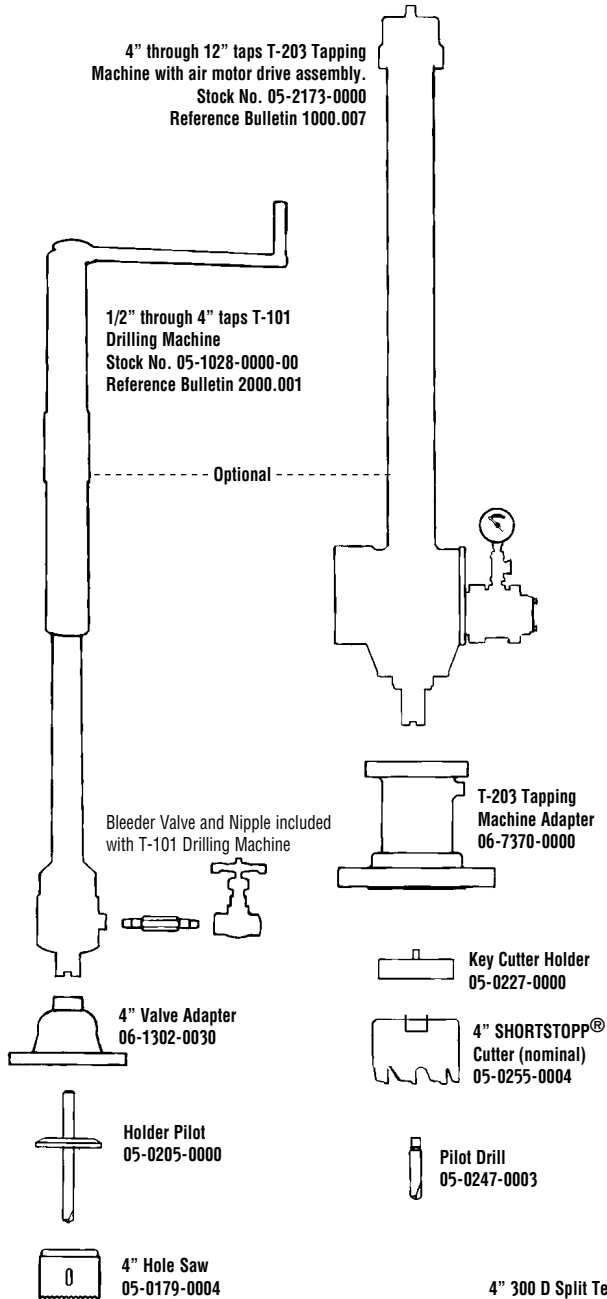

Plugging

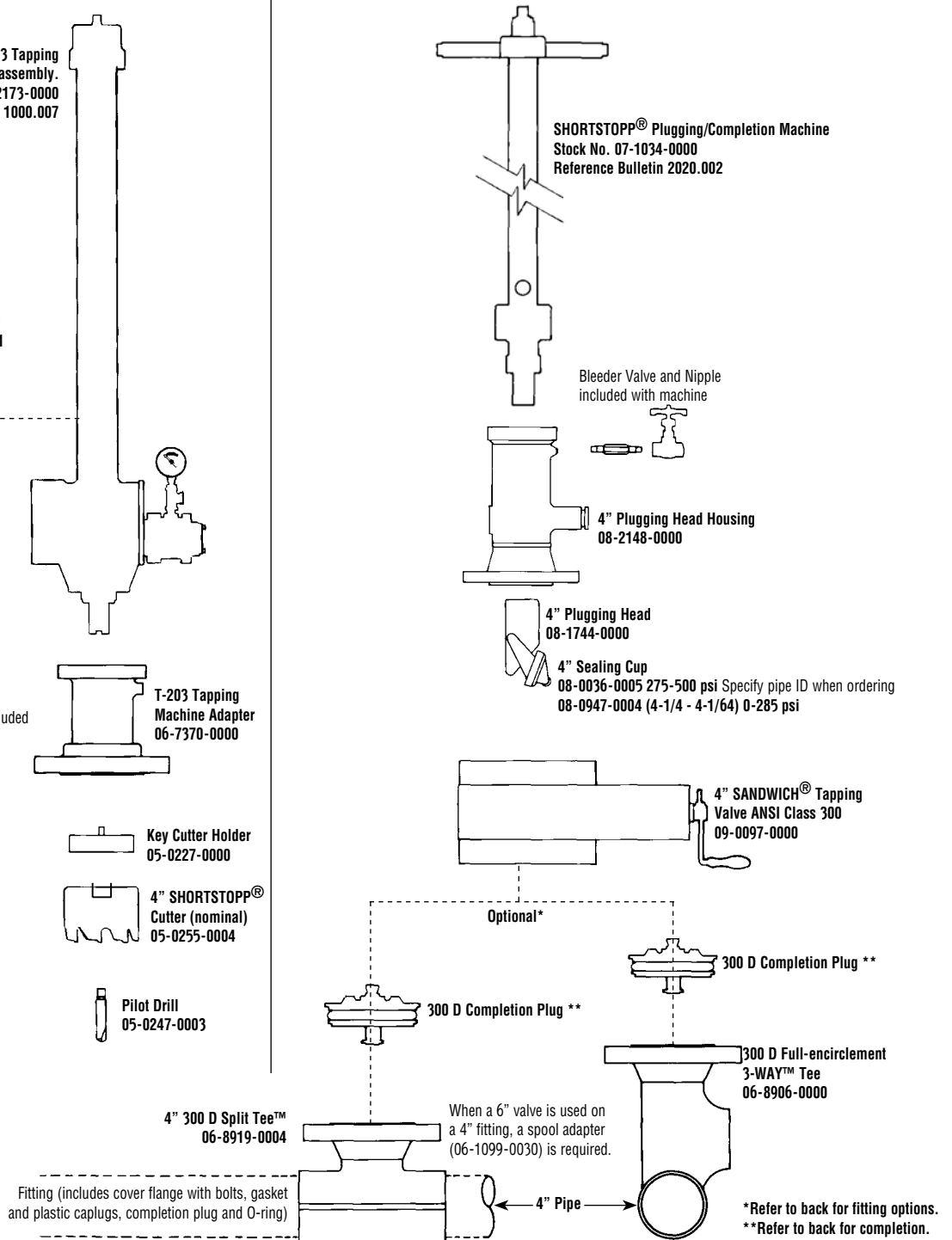



T.D. Williamson, Inc.

Data Sheet No. **SS500-4**

Fittings

Tapping and **SHORTSTOPP®** Plugging Machine 4" Gas Main to 500 psi

Data Sheet No. **SS500-4**



■ **Welding Fitting and SHORTPLUG™ with Guide Bars**
See Bulletin 2100.013

■ **Welding Fitting**
See Bulletin 2100.003

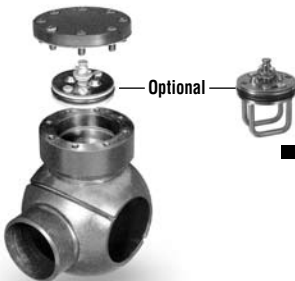

■ **Spherical 3-WAY™ Tee and SHORTPLUG™ with Guide Bars**
See Bulletin 2100.014

■ **Spherical 3-WAY™ Tee**
See Bulletin 2100.007



■ **3-WAY™ Tee and SHORTPLUG™ with Guide Bars**
See Bulletin 2100.012

■ **3-WAY™ Tee**
See Bulletin 2100.002



■ **Mechanical SHORTSLEEVE™ Fitting**
See Bulletin 2110.001

■ **Note:** Consult your TDW representative for additional fitting options.

Completion

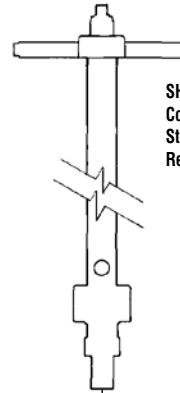

SHORTSTOPP® Plugging/Completion Machine
Stock No. 07-1034-0000
Reference Bulletin 2020.002

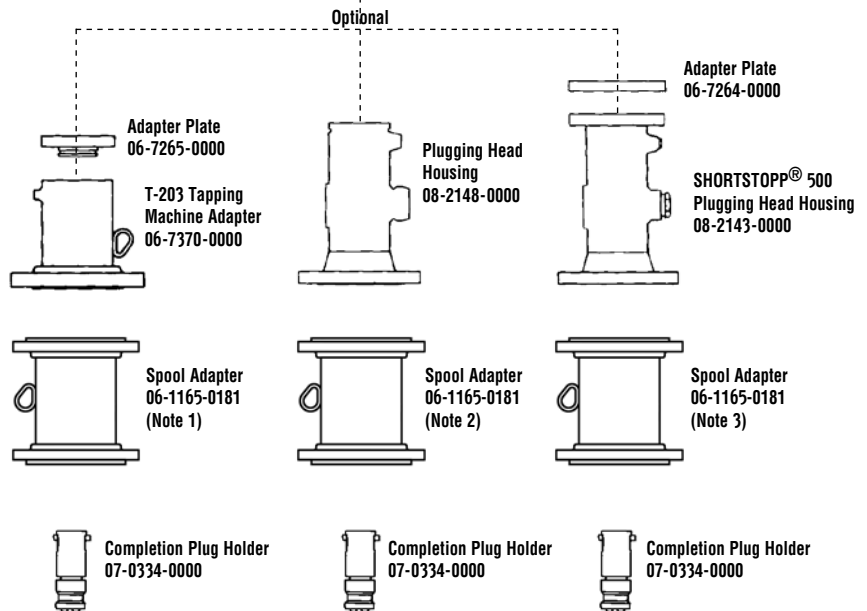

- **Note 1:** 4-inch Spool Adapter required to set 4-inch SHORTPLUG™ with Guide Bars in all SHORTSTOPP 300D Split Tee Fittings using the 06-7370-0000 Housing
- **Note 2:** 4-inch Spool Adapter required to set 4-inch SHORTPLUG™ with Guide Bars in all SHORTSTOPP 300D 3-Way™ Tee Fittings using the 08-2148-0000 Housing
- **Note 3:** 4-inch Spool Adapter required to set 4-inch SHORTPLUG™ with Guide Bars in all SHORTSTOPP 300D 3-Way™ Tee Fittings using the 08-2143-0000 Housing

Tapping and SHORTSTOPP® Plugging Machine

*Equipment Needed to Plug a 4" Gas Main to 500 psi
using Jackscrew Actuator*



T.D. Williamson, Inc.

Data Sheet No. **SS500-4A**

Date: November 2004

Supersedes: September 2002

Data Sheet No. SS500-4A

Tapping

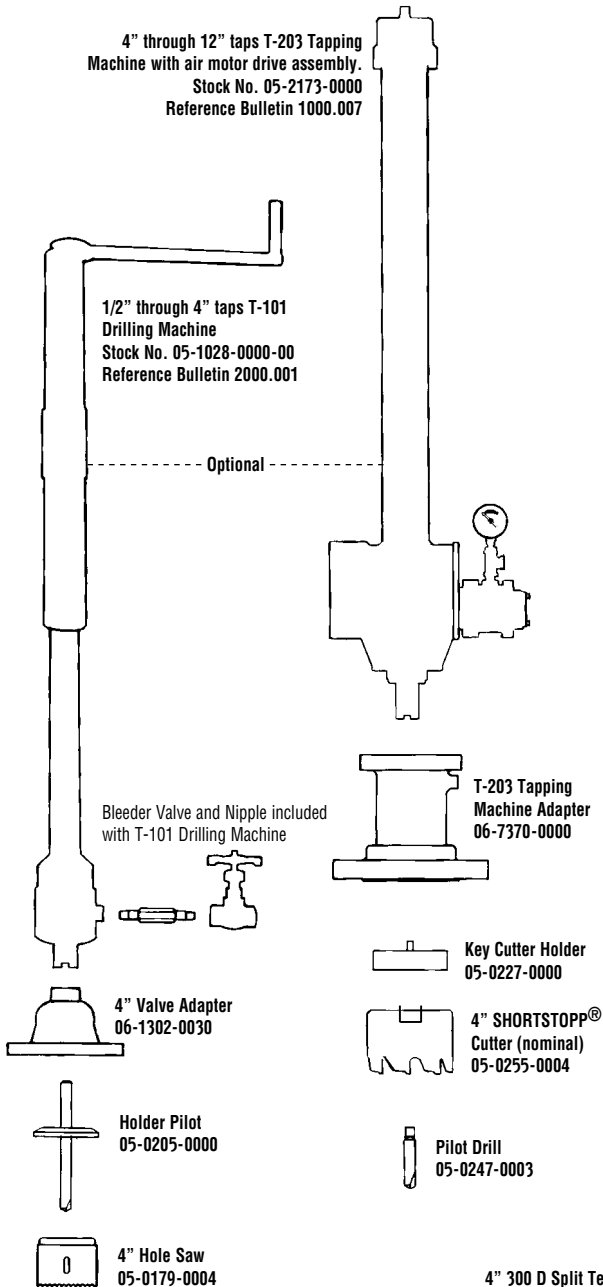

Plugging

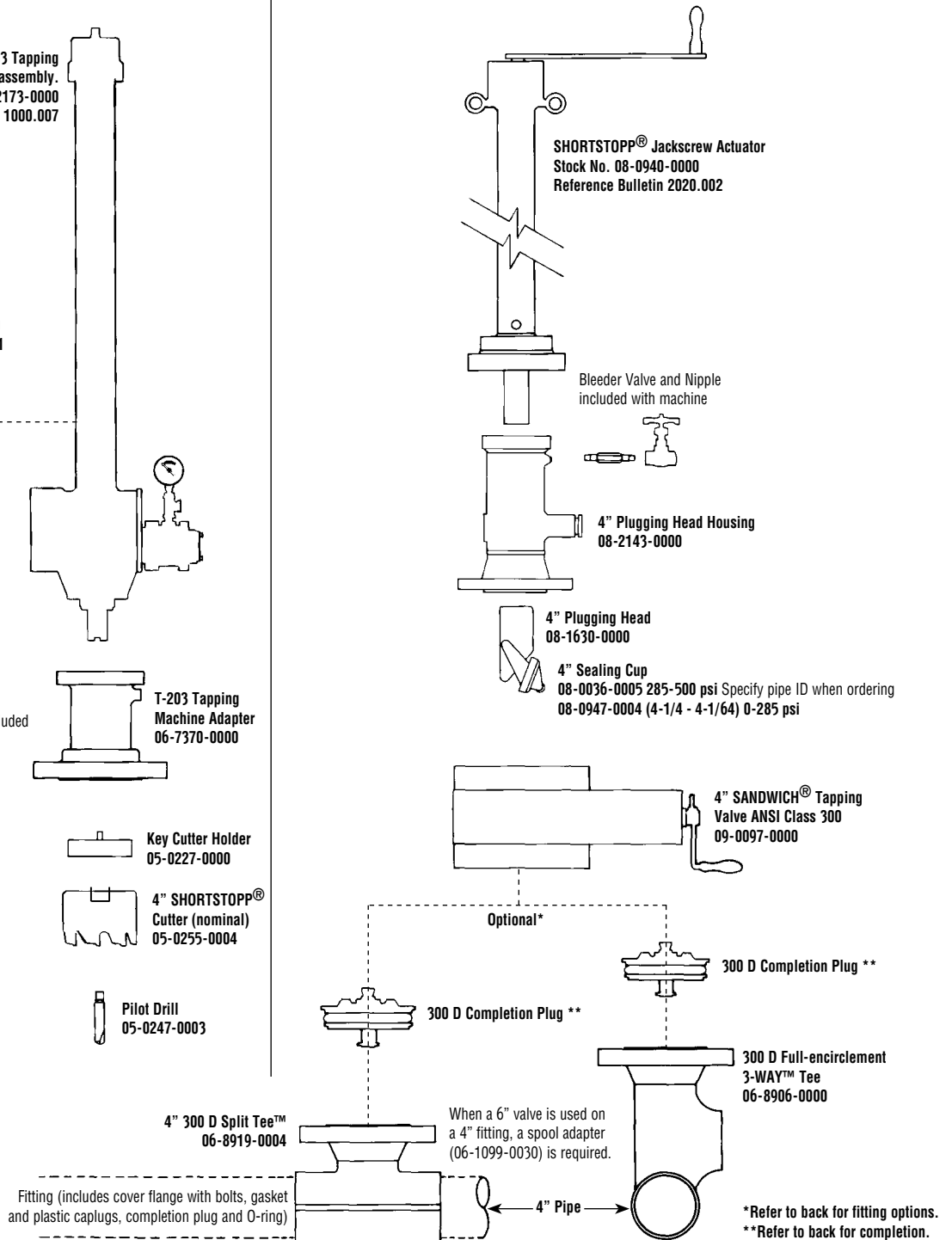



T.D. Williamson, Inc.

Data Sheet No. **SS500-4A**

Fittings

Tapping and **SHORTSTOPP®** Plugging Machine

4" Gas Main to 500 psi

Data Sheet No. **SS500-4A**

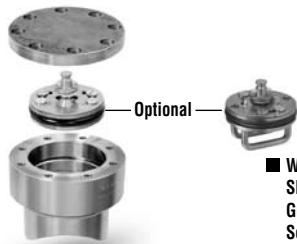

■ **Welding Fitting and SHORTPLUG™ with Guide Bars**
See Bulletin 2100.013

■ **Welding Fitting**
See Bulletin 2100.003

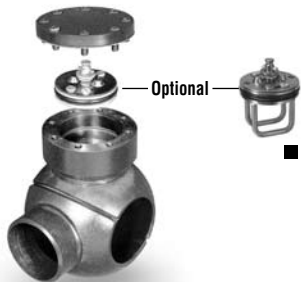

■ **Spherical 3-WAY™ Tee and SHORTPLUG™ with Guide Bars**
See Bulletin 2100.014

■ **Spherical 3-WAY™ Tee**
See Bulletin 2100.007



■ **3-WAY™ Tee and SHORTPLUG™ with Guide Bars**
See Bulletin 2100.012

■ **3-WAY™ Tee**
See Bulletin 2100.002



■ **Mechanical SHORTSLEEVE™ Fitting**
See Bulletin 2110.001

■ **Note:** Consult your TDW representative for additional fitting options.

Completion

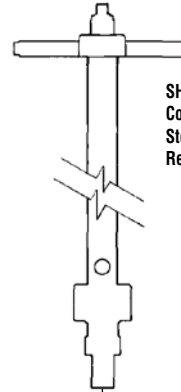

SHORTSTOPP® Plugging/Completion Machine
Stock No. 07-1034-0000
Reference Bulletin 2020.002

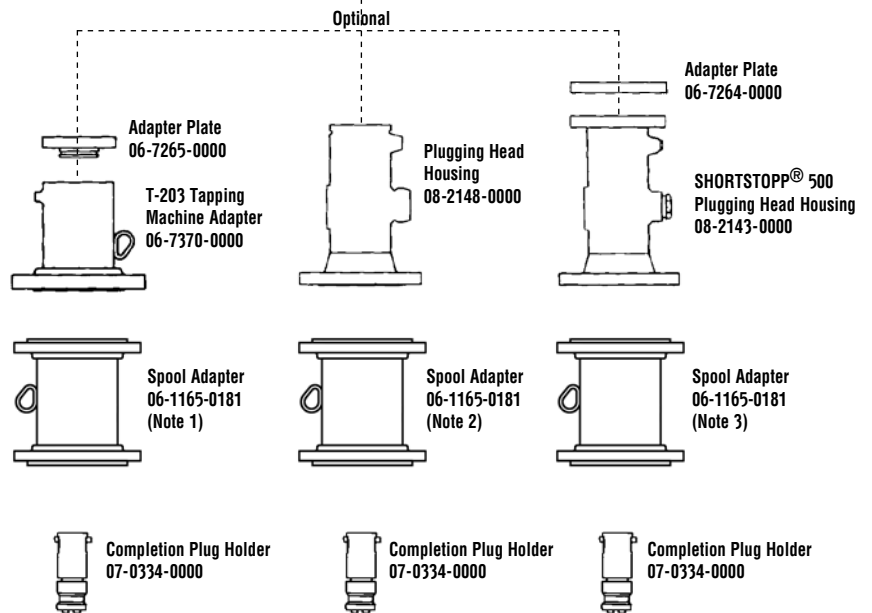

■ **Note 1:** 4-inch Spool Adapter required to set 4-inch SHORTPLUG™ with Guide Bars in all SHORTSTOPP 300D Split Tee Fittings using the 06-7370-0000 Housing

■ **Note 2:** 4-inch Spool Adapter required to set 4-inch SHORTPLUG™ with Guide Bars in all SHORTSTOPP 300D 3-Way™ Tee Fittings using the 08-2148-0000 Housing

■ **Note 3:** 4-inch Spool Adapter required to set 4-inch SHORTPLUG™ with Guide Bars in all SHORTSTOPP 300D 3-Way™ Tee Fittings using the 08-2143-0000 Housing

Tapping and SHORTSTOPP® Plugging Machine

Equipment Needed to Plug a 6" Gas Main to 500 psi



T.D. Williamson, Inc.

Data Sheet No. **SS500-6**

Date: November 2004

Supersedes: September 2002

Tapping

■ Note: Either the T-101 XL or T-203 Tapping Machine is recommended for 6" taps.

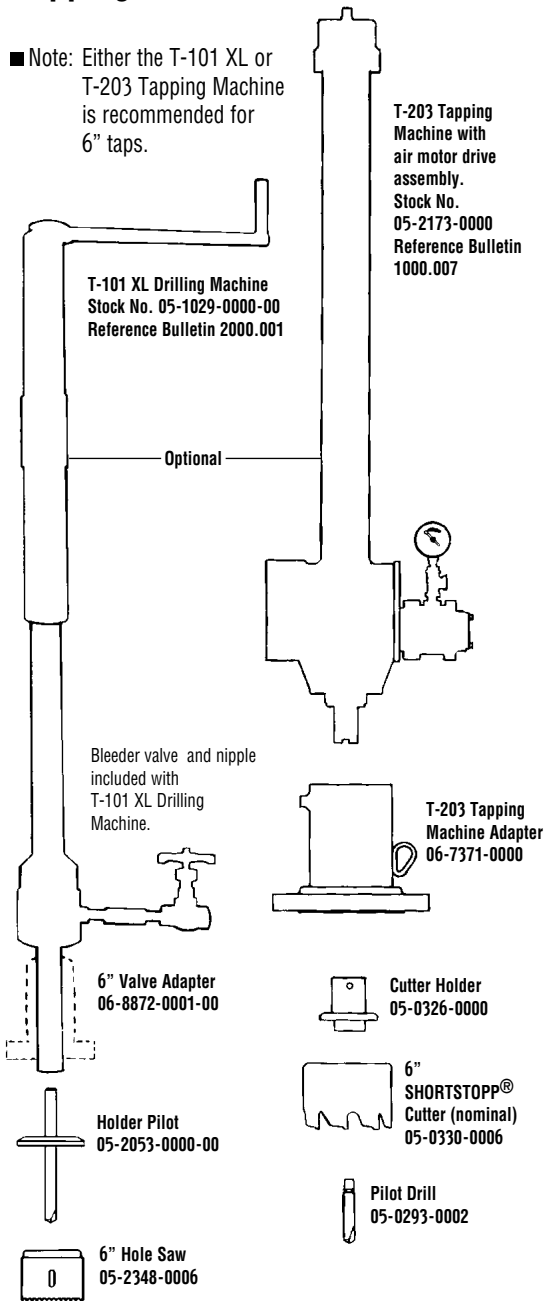

Plugging

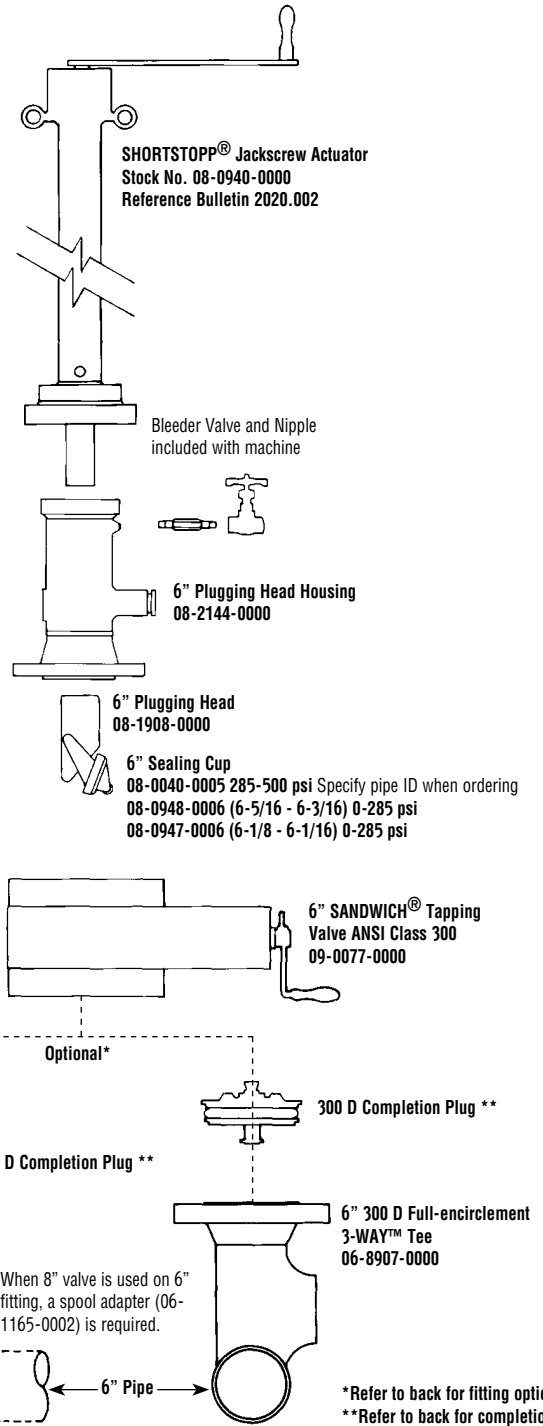



T.D. Williamson, Inc.

Data Sheet No. **SS500-6**

Fittings

Tapping and **SHORTSTOPP®** Plugging Machine

6" Gas Main to 500 psi

Data Sheet No. **SS500-6**

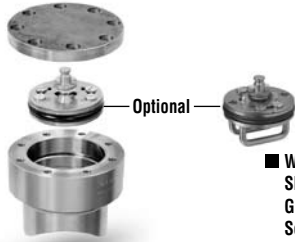

Optional

■ **Welding Fitting and SHORTPLUG™ with Guide Bars**
See Bulletin 2100.013

■ **Welding Fitting**
See Bulletin 2100.003

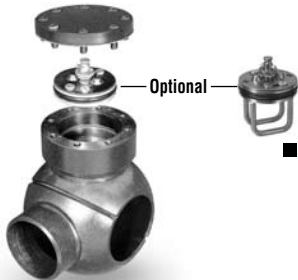

Optional

■ **Spherical 3-WAY™ Tee and SHORTPLUG™ with Guide Bars**
See Bulletin 2100.014

■ **Spherical 3-WAY™ Tee**
See Bulletin 2100.007

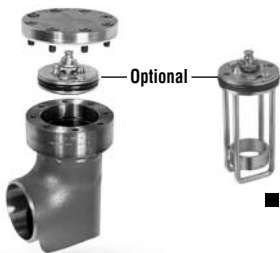

Optional

■ **3-WAY™ Tee and SHORTPLUG™ with Guide Bars**
See Bulletin 2100.012

■ **3-WAY™ Tee**
See Bulletin 2100.002



■ **Mechanical SHORTSLEEVE™ Fitting**
See Bulletin 2110.001

■ **Note:** Consult your TDW representative for additional fitting options.

Completion

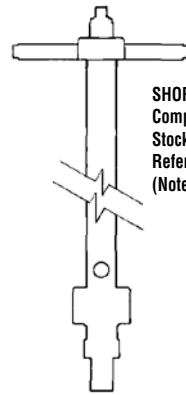

SHORTSTOPP® Plugging/Completion Machine
Stock No. 07-1034-0000
Reference Bulletin 2020.002
(Note 3)

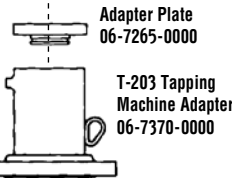

Adapter Plate
06-7265-0000

T-203 Tapping Machine Adapter
06-7370-0000

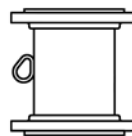

Spool Adapter
06-1165-0182
(Note 1)



Completion Plug Holder
07-0334-0000

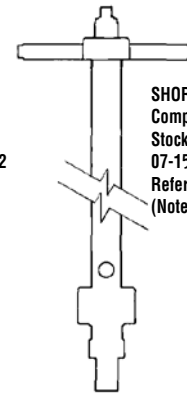

SHORTSTOPP® Plugging/Completion Machine
Stock No. 07-1034-0000 or 07-1586-0000
Reference Bulletin 2020.002
(Note 3)

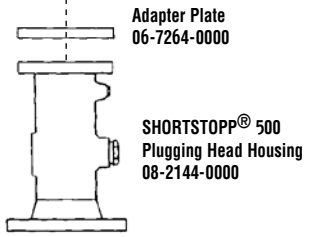

Adapter Plate
06-7264-0000

SHORTSTOPP® 500 Plugging Head Housing
08-2144-0000



Spool Adapter
06-1165-0182
(Note 2)



Completion Plug Holder
07-0334-0000

- **Note 1:** 6-inch Spool Adapter required to set 6-inch SHORTPLUG™ with Guide Bars in SHORTSTOPP 300D 3-Way™ Tee and Spherical Fittings using the 06-7371-0000 Housing.
- **Note 2:** 6-inch Spool Adapter required to set 6-inch SHORTPLUG™ with Guide Bars in all SHORTSTOPP 300D 3-Way™ Tee Fittings using the 08-2144-0000 Adapter. Also required is the 07-1586-0000 Completion Machine with 48-inch travel.
- **Note 3:** 07-1586-0000 Completion Machine with 48-inch travel is required to set 6-inch SHORTPLUG™ with Guide Bars in SHORTSTOPP 300D 3-Way™ Tee Fittings using the 08-2144-0000 Housing.

Tapping and SHORTSTOPP® Plugging Machine

Equipment Needed to Plug a 8" Gas Main to 500 psi



T.D. Williamson, Inc.

Data Sheet No. **SS500-8**

Date: November 2004

Supersedes: September 2004

Tapping

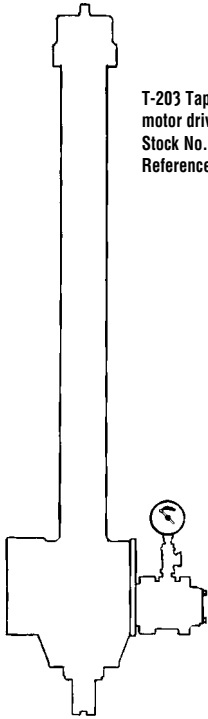

T-203 Tapping Machine with air motor drive assembly.
Stock No. 05-2173-0000
Reference Bulletin 1000.007



T-203 Tapping Machine Adapter
06-7372-0000



Cutter Holder
05-0326-0006



8" SHORTSTOPP®
Cutter (nominal)
05-0330-0008



Pilot Drill
05-0293-0003

Plugging

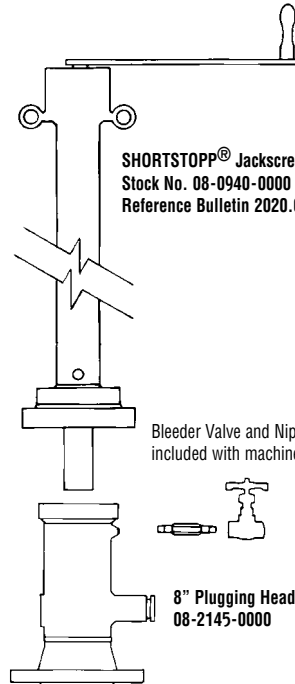

SHORTSTOPP® Jackscrew Actuator
Stock No. 08-0940-0000
Reference Bulletin 2020.002

Bleeder Valve and Nipple
included with machine

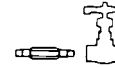

8" Plugging Head Housing
08-2145-0000



8" Plugging Head
08-1909-0000

8" Sealing Cup

08-0246-0005 285-500 psi Specify pipe ID when ordering
08-0948-0008 (8-11/32 - 8-1/16) 0-285 psi
08-0947-0008 (8 - 7-31/32) 0-285 psi

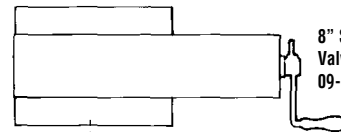

8" SANDWICH® Tapping
Valve ANSI Class 300
09-0064-0000

Optional*

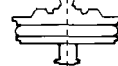

300 D Completion Plug **



300 D Completion Plug **

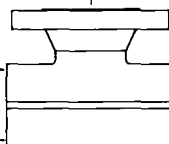

8" 300 D Split Tee
06-8919-0008

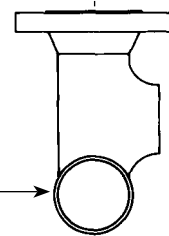

8" 300 D Full-Encirclement
3-WAY™ Tee
06-8908-0000

8" Pipe

*Refer to back for fitting options.
**Refer to back for completion.



T.D. Williamson, Inc.

Data Sheet No. **SS500-8**

Fittings

Tapping and **SHORTSTOPP®** Plugging Machine

8" Gas Main to 500 psi

Data Sheet No. **SS500-8**

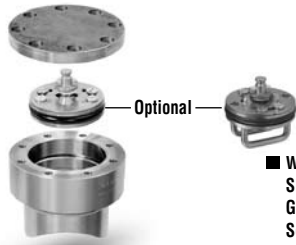

■ **Welding Fitting and SHORTPLUG™ with Guide Bars**
See Bulletin 2100.013

■ **Welding Fitting**
See Bulletin 2100.003

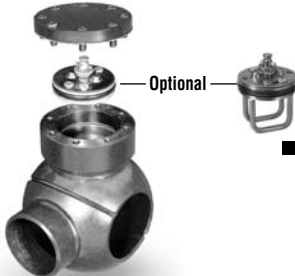

■ **Spherical 3-WAY™ Tee and SHORTPLUG™ with Guide Bars**
See Bulletin 2100.014

■ **Spherical 3-WAY™ Tee**
See Bulletin 2100.007

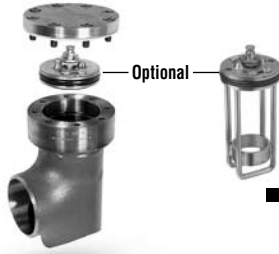

■ **3-WAY™ Tee and SHORTPLUG™ with Guide Bars**
See Bulletin 2100.012

■ **3-WAY™ Tee**
See Bulletin 2100.002



■ **Mechanical SHORTSLEEVE™ Fitting**
See Bulletin 2110.001

■ **Note:** Consult your TDW representative for additional fitting options.

Completion

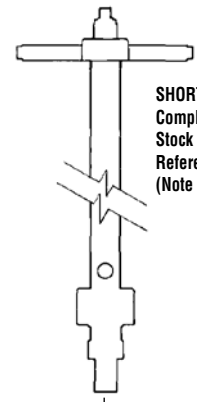

SHORTSTOPP® Plugging/Completion Machine
Stock No. 07-1034-0000
Reference Bulletin 2020.002
(Note 3)

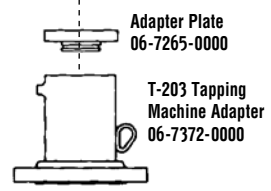

Adapter Plate
06-7265-0000
T-203 Tapping Machine Adapter
06-7372-0000

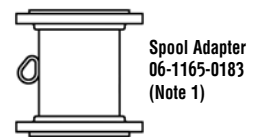

Spool Adapter
06-1165-0183
(Note 1)



Completion Plug Holder
07-0334-0000

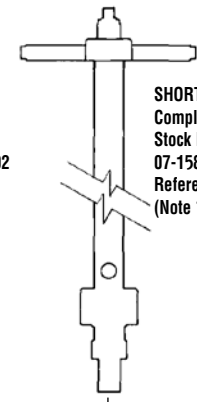

SHORTSTOPP® Plugging/Completion Machine
Stock No. 07-1034-0000 or 07-1586-0000
Reference Bulletin 2020.002
(Note 3)



Adapter Plate
06-7264-0000
SHORTSTOPP® 500 Plugging Head Housing
08-2145-0000

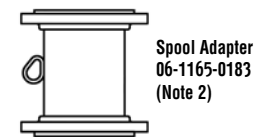

Spool Adapter
06-1165-0183
(Note 2)



Completion Plug Holder
07-0334-0000

- **Note 1:** 8-inch Spool Adapter required to set 8-inch SHORTPLUG™ with Guide Bars in SHORTSTOPP 300D 3-Way™ Tee Fittings using the 06-7372-0000 Housing.
- **Note 2:** 8-inch Spool Adapter required to set 8-inch SHORTPLUG™ with Guide Bars in all SHORTSTOPP 300D 3-Way™ Tee Fittings using the 08-2145-0000 Adapter. Also required is the 07-1586-0000 Completion Machine with 48-inch travel.
- **Note 3:** 07-1586-0000 Completion Machine with 48-inch travel is required to set 8-inch SHORTPLUG™ with Guide Bars in SHORTSTOPP 300D 3-Way™ Tee Fittings using the 08-2145-0000 Housing.

Tapping and SHORTSTOPP® Plugging Machine

*Equipment Needed to Plug a 10" Gas Main to 500 psi
through a 10-inch 300D Split Tee or Spherical Fitting*



T.D. Williamson, Inc.

Data Sheet No. **SS500-10**

Date: November 2004

Supersedes: October 2002

Tapping

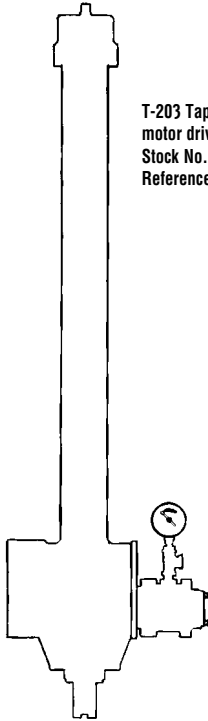

T-203 Tapping Machine with air motor drive assembly.
Stock No. 05-2173-0000
Reference Bulletin 1000.007

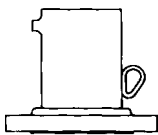

T-203 Tapping Machine Adapter
06-7373-0000



Cutter Holder
05-0326-0000



10" SHORTSTOPP®
Cutter (nominal)
05-0330-0010



Pilot Drill
05-0293-0004

Plugging

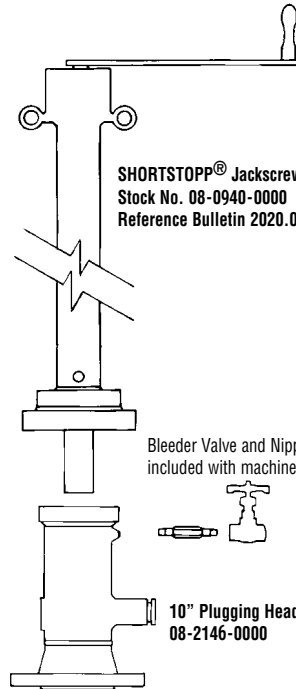

SHORTSTOPP® Jackscrew Actuator
Stock No. 08-0940-0000
Reference Bulletin 2020.002

Bleeder Valve and Nipple
included with machine

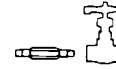

10" Plugging Head Housing
08-2146-0000

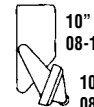

10" Plugging Head
08-1910-0000

10" Sealing Cup

08-0247-0005 285-500 psi Specify pipe ID when ordering
08-0948-0010 (10-3/8 - 10-3/16) 0-285 psi
08-0947-0010 (10-1/8 - 10-1/64) 0-285 psi

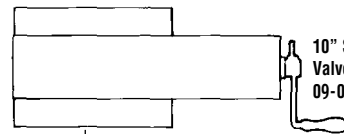

10" SANDWICH® Tapping
Valve ANSI Class 300
09-0106-0000

Optional*

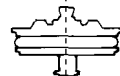

300 D Completion Plug **

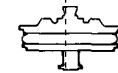

300 D Completion Plug **

10" 300 D Split Tee™
06-8919-0010

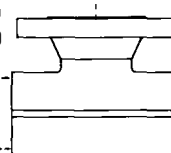

When 12" valve is used on 10" fitting, a spool adapter (06-1165-0001) is required.

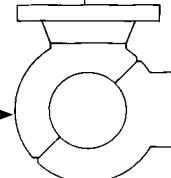

10" 300 D Spherical 3-WAY™ Tee
26-1141-0000

10" Pipe

*Refer to back for fitting options.
**Refer to back for completion.



T.D. Williamson, Inc.

Data Sheet No. **SS500-10**

Fittings

Tapping and **SHORTSTOPP®** Plugging Machine 10" Gas Main to 500 psi through a 12-inch **SHORTSTOPP®** 300D Split Tee or Spherical Fitting

Data Sheet No. **SS500-10**



Optional

■ **SHORTSTOPP®** 300D Split Tees and **SHORTPLUG™** with Guide Bars
See Bulletin 2100.004

■ **300 D Full-encirclement Split Tee™**
See Bulletin 2100.004



Optional

■ **300D Spherical 3-Way™** Tee and **SHORTPLUG™** with Guide Bars
See Bulletin 2100.017

■ **300 D Spherical 3-WAY™** Tee
See Bulletin 2100.008

Completion

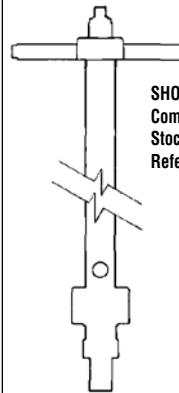

SHORTSTOPP® Plugging/
Completion Machine
Stock No. 07-1586-0000
Reference Bulletin 2020.002

Adapter Plate
06-7264-0000
T-203 Tapping
Machine Adapter
06-7373-0000

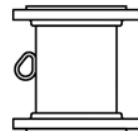

Spool Adapter
06-1165-0184



Completion Plug Holder
07-0335-0000

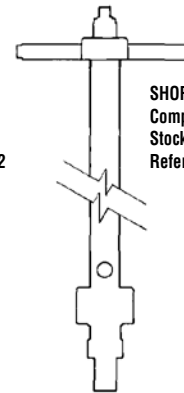

SHORTSTOPP® Plugging/
Completion Machine
Stock No. 07-1034-0000
Reference Bulletin 2020.002

Adapter Plate
06-7264-0000

SHORTSTOPP® 500
Plugging Head Housing
08-2146-0000



Completion Plug Holder
07-0334-0000

■ Note 1: For Tapping and Plugging through a **SHORTSTOPP®** 300D 3-Way Tee™ see SS500-10A Data Sheet.

■ Note 2: Consult your TDW representative for additional fitting options.

Tapping and SHORTSTOPP® Plugging Machine

*Equipment Needed to Plug a 12" Gas Main to 500 psi
through a 12-inch 300D Split Tee or Spherical Fitting*



T.D. Williamson, Inc.

Data Sheet No. **SS500-12**

Date: November 2004

Supersedes: October 2002

Tapping

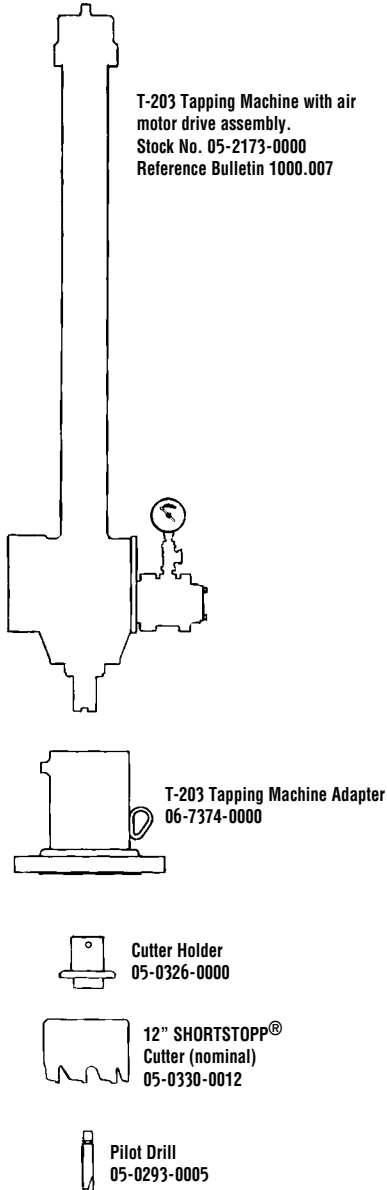

Plugging

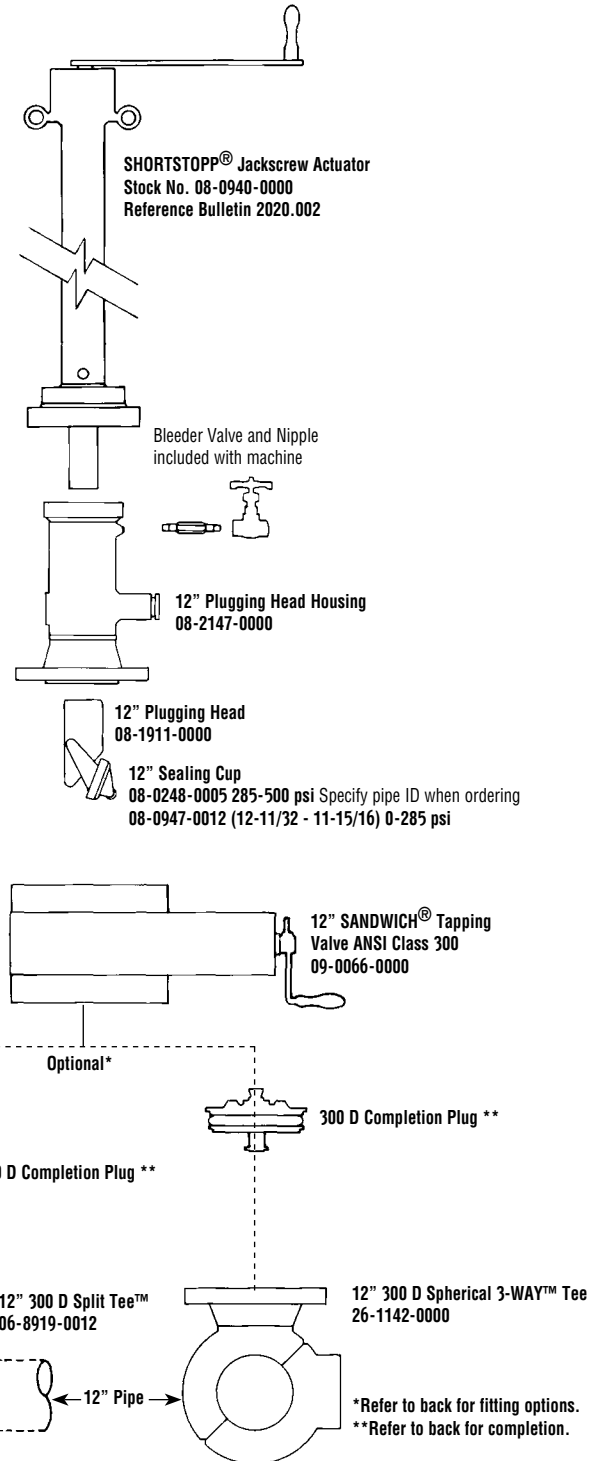



T.D. Williamson, Inc.

Data Sheet No. SS500-12

Fittings

Tapping and SHORTSTOPP® Plugging Machine 12-inch Gas Main to 500 psi through a 12-inch SHORTSTOPP® 300D Split Tee or Spherical Fitting

Data Sheet No. SS500-12



Optional



■ SHORTSTOPP® 300D Split Tees and SHORTPLUG™ with Guide Bars See Bulletin 2100.004

■ 300 D Full-encirclement Split Tee™ See Bulletin 2100.004



Optional



■ 300D Spherical 3-Way™ Tee and SHORTPLUG™ with Guide Bars See Bulletin 2100.017

■ 300 D Spherical 3-WAY™ Tee See Bulletin 2100.008

Completion

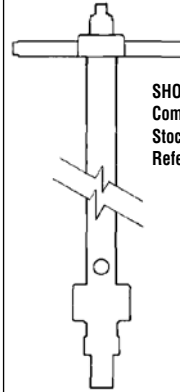

SHORTSTOPP® Plugging/Completion Machine
Stock No. 07-1034-0000
Reference Bulletin 2020.002

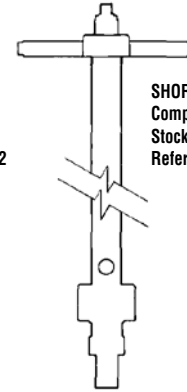

SHORTSTOPP® Plugging/Completion Machine
Stock No. 07-1034-0000
Reference Bulletin 2020.002

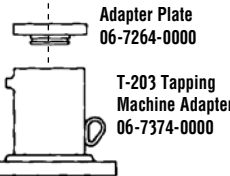

Adapter Plate
06-7264-0000

T-203 Tapping Machine Adapter
06-7374-0000

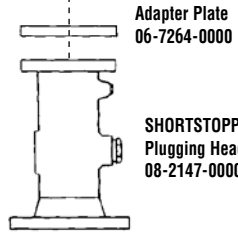

Adapter Plate
06-7264-0000

SHORTSTOPP® 500 Plugging Head Housing
08-2147-0000



Completion Plug Holder
07-0335-0000



Completion Plug Holder
07-0335-0000

■ Note 1: For Tapping and Plugging through a SHORTSTOPP® 300D 3-Way Tee™ see SS500-12A Data Sheet.

■ Note 2: Consult your TDW representative for additional fitting options.

Tapping and SHORTSTOPP® Plugging Machine

*Equipment Needed to Plug a 12" Gas Main to 500 psi
through a 12-inch 300D Split Tee or Spherical Fitting*



T.D. Williamson, Inc.

Data Sheet No. **SS500-12A**

Date: November 2004

Supersedes: NA

Tapping

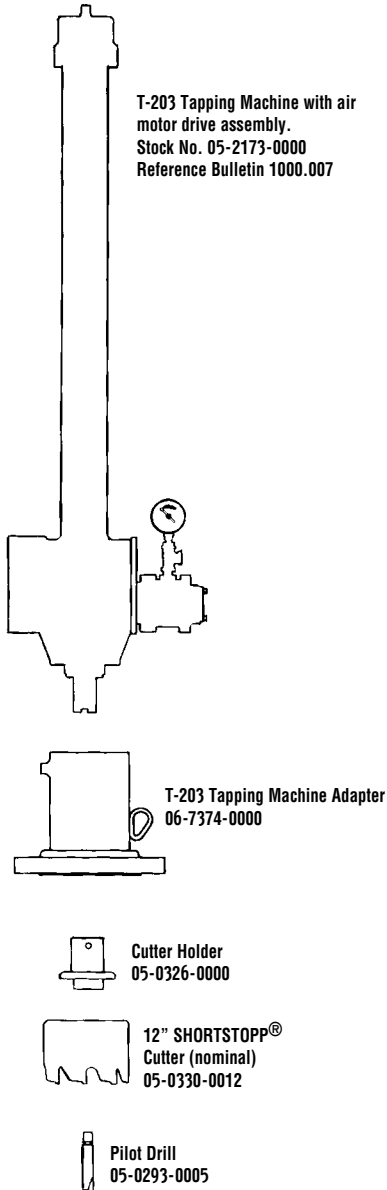

Plugging

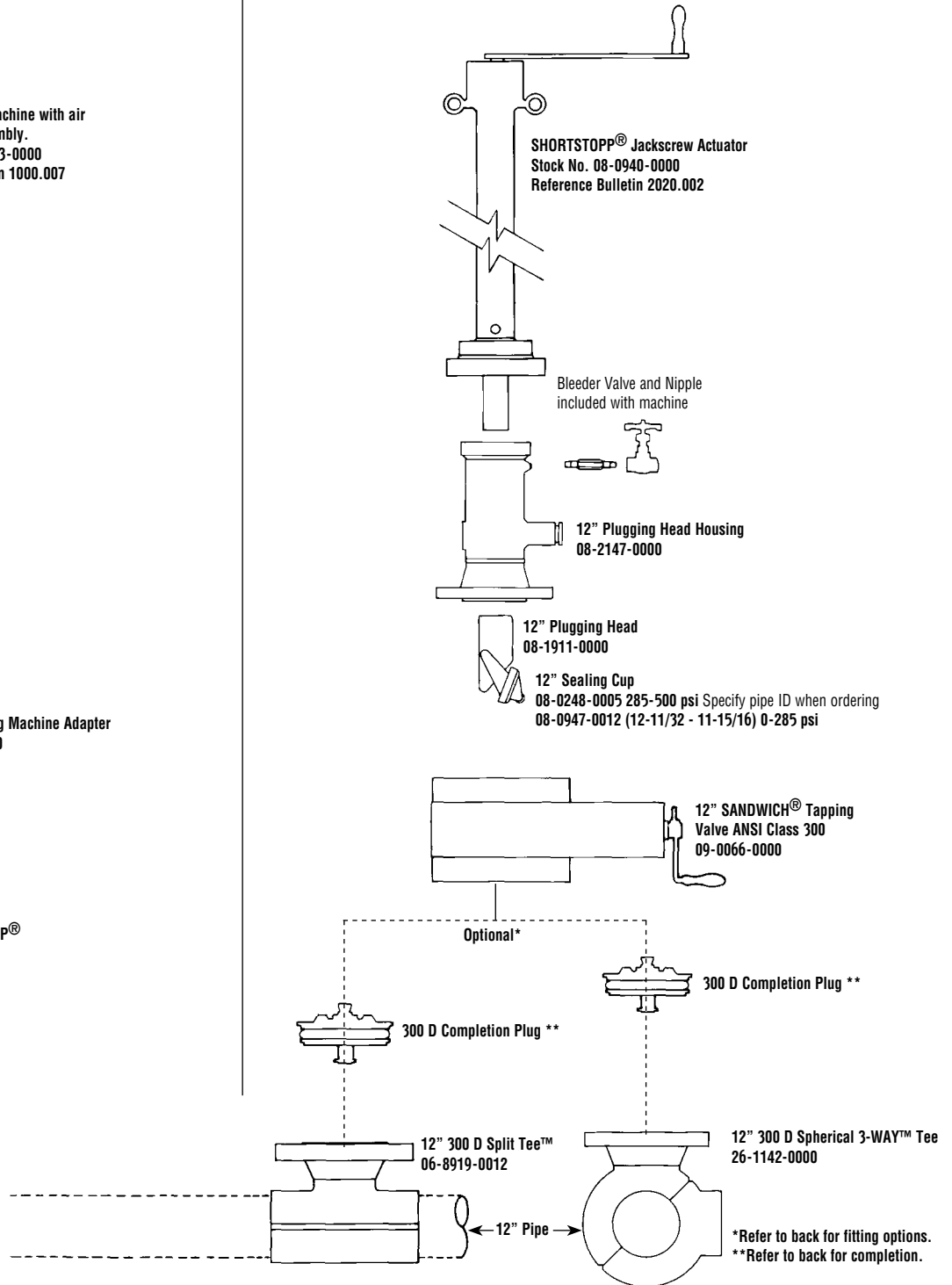



T.D. Williamson, Inc.

Data Sheet No. SS500-12A

Fittings

Tapping and SHORTSTOPP® Plugging Machine

12-inch Gas Main to 500 psi through a 12-inch SHORTSTOPP® 300D Split Tee or Spherical Fitting

Completion

Data Sheet No. SS500-12A



Optional



■ SHORTSTOPP® 300D Split Tees and SHORTPLUG™ with Guide Bars See Bulletin 2100.004

■ 300 D Full-encirclement Split Tee™ See Bulletin 2100.004



Optional



■ 300D Spherical 3-Way™ Tee and SHORTPLUG™ with Guide Bars See Bulletin 2100.017

■ 300 D Spherical 3-WAY™ Tee See Bulletin 2100.008

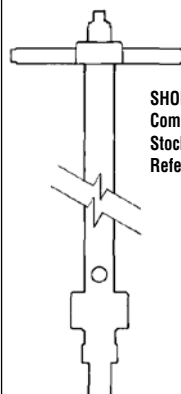

SHORTSTOPP® Plugging/Completion Machine
Stock No. 07-1034-0000
Reference Bulletin 2020.002

Adapter Plate
06-7264-0000

T-203 Tapping Machine Adapter
06-7374-0000

Completion Plug Holder
07-0335-0000

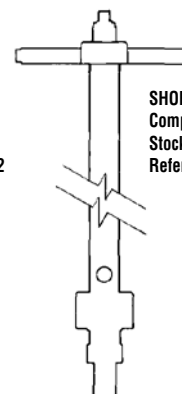

SHORTSTOPP® Plugging/Completion Machine
Stock No. 07-1034-0000
Reference Bulletin 2020.002

Adapter Plate
06-7264-0000

SHORTSTOPP® 500 Plugging Head Housing
08-2147-0000

Completion Plug Holder
07-0335-0000

■ Note 1: For Tapping and Plugging through a SHORTSTOPP® 300D 3-Way Tee™ see SS500-12A Data Sheet.

■ Note 2: Consult your TDW representative for additional fitting options.

Tapping and SHORTSTOPP® Plugging Machine

*Equipment Needed to Plug a 12" Gas Main to 500 psi
through a 12-inch 300D Split Tee or Spherical Fitting*



T.D. Williamson, Inc.

Data Sheet No. **SS500-12A**
Date: November 2004
Supersedes: NA

Tapping

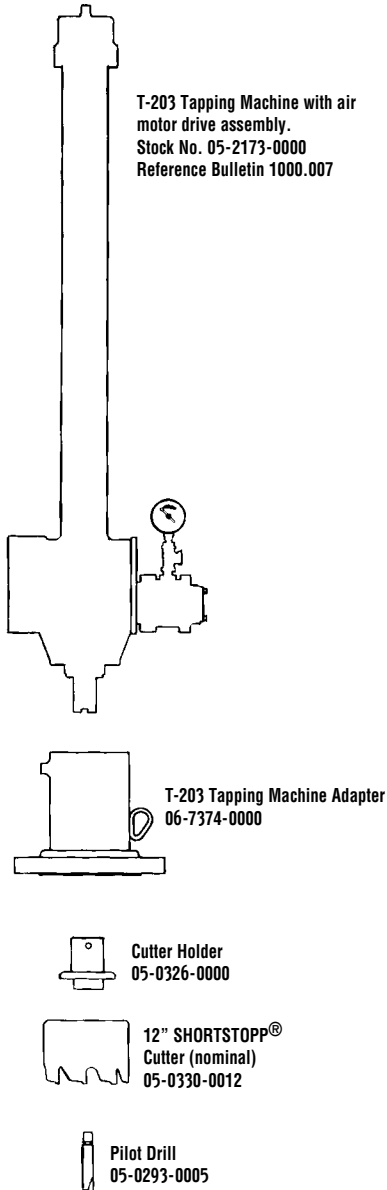

Plugging

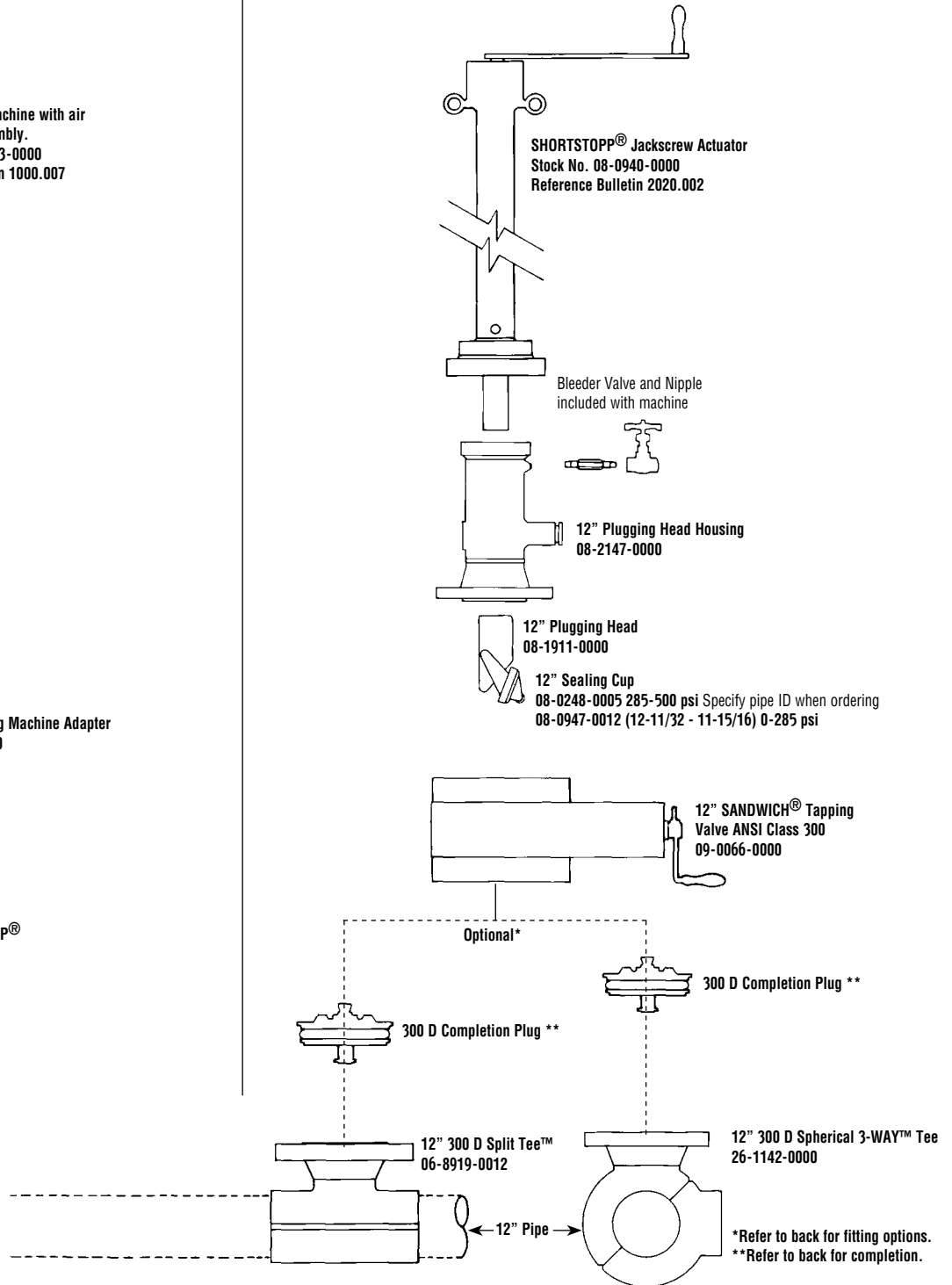



T.D. Williamson, Inc.

Data Sheet No. **SS500-12A**

Fittings

Tapping and **SHORTSTOPP®** Plugging Machine 12-inch Gas Main to 500 psi through a 12-inch **SHORTSTOPP®** 300D Split Tee or Spherical Fitting

Data Sheet No. **SS500-12**

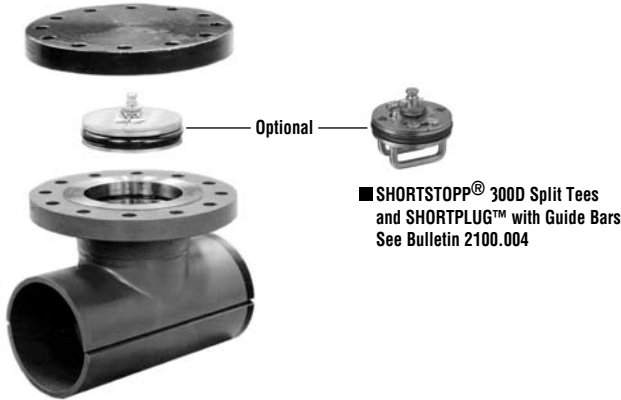

■ 300 D Full-encirclement Split Tee™
See Bulletin 2100.004

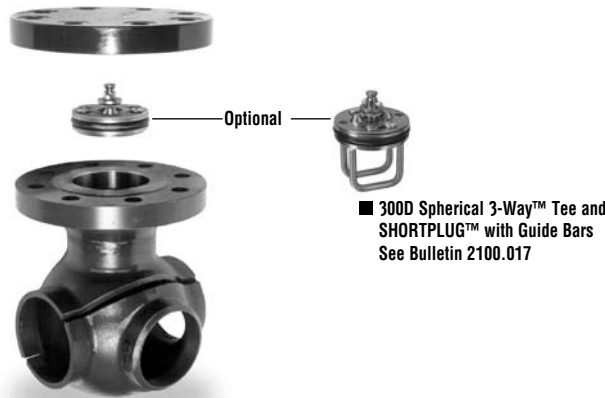

■ 300 D Spherical 3-WAY™ Tee
See Bulletin 2100.008

Completion

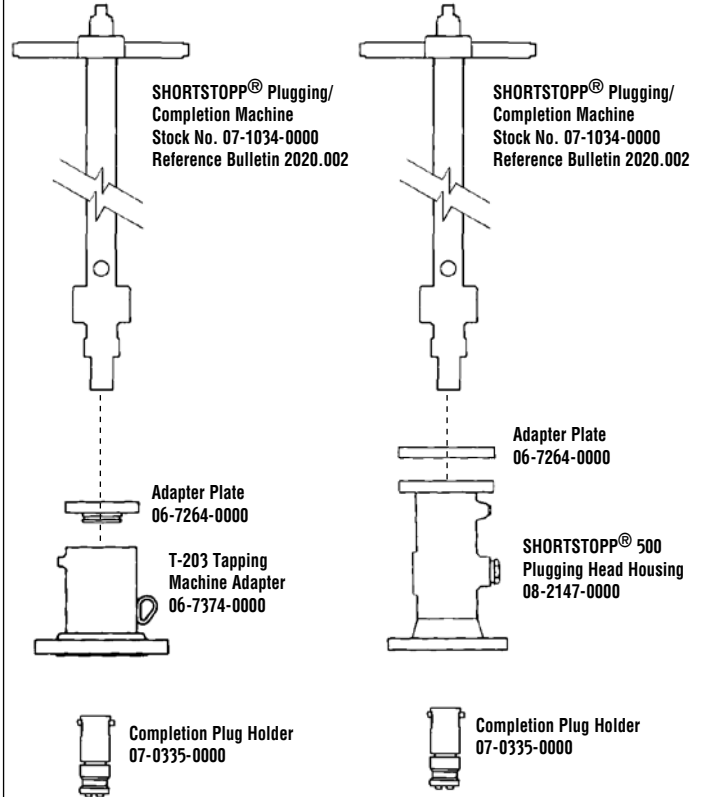

■ Note 1: For Tapping and Plugging through a **SHORTSTOPP®** 300D 3-Way Tee™ see SS500-12A Data Sheet.

■ Note 2: Consult your TDW representative for additional fitting options.